



- Ask a qualified installer or contractor to install this product. Do not try to install the product yourself. Improper installation can result in water or refrigerant leakage, electrical shock, fire or explosion.
- Use only those parts and accessories supplied or specified by Daikin. Ask a qualified installer or contractor to install those parts and accessories. Use of unauthorised parts and accessories or improper installation of parts and accessories can result in water or refrigerant leakage, electrical shock, fire or explosion.
- Read the user's manual carefully before using this product. The user's manual provides important safety instructions and warnings. Be sure to follow these instructions and warnings.

If you have any enquiries, please contact your local importer, distributor and/or retailer.

Cautions on product corrosion

1. Air conditioners should not be installed in areas where corrosive gases, such as acid gas or alkaline gas, are produced.
2. If the outdoor unit is to be installed close to the sea shore, direct exposure to the sea breeze should be avoided. If you need to install the outdoor unit close to the sea shore, contact your local distributor.

Daikin Airconditioning (Hong Kong) Ltd.

17-18F, Futura Plaza, 111-113 How Ming Street
Kwun Tong, Kowloon, Hong Kong.
Tel : (852) 2570 2786
Fax: (852) 2807 2484
www.daikin.com.hk



ISO 14001 : 2004
Certificate No.: CC 3416

VRV is a trademark of Daikin Industries, Ltd.
VRV Air Conditioning System is the world's first individual air conditioning system with variable refrigerant flow control and was commercialised by Daikin in 1982.
VRV is the trademark of Daikin Industries, Ltd., which is derived from the technology we call "variable refrigerant volume."

Specifications, designs and other content appearing in this brochure are current as of September 2019 but subject to change without notice.

©All rights reserved 09/19 AK



PCTVHK1911-1

DAIKIN
VRV
A SERIES



VRV A SERIES

Cooling Only 50 Hz

Cooling Only 50 Hz

R-410A

Exceeding Boundaries with Innovative Energy Savings

VRV A SERIES



VRV A series movie



First launched in Japan in 1982, the Daikin **VRV** system has been embraced by world markets for over 35 years. Now, Daikin proudly introduces the new **VRV A** series. By combining the technologies of **VRV**, **VRT** and **VAV**, we have attained both energy savings and comfortable air conditioning.

VRV+VRT+VAV

Energy savings

Uniting **VRV**, **VRT** and **VAV** technologies

Automatic refrigerant charge function

- Optimised operation efficiency
- Higher installation quality
- Easier installation

High reliability

- New inverter PC board
- Double backup operation
- Refrigerant cooling for PC board

Contents

New Products Information	3	
Main Features	5	
VRV A MAX (Heavy Anti-corrosion)	15	
Outdoor Unit Lineup	17	
Specifications	19	
Indoor Unit Lineup	21	
VRV Indoor Units	Type	
FXFSQ-A	Ceiling Mounted Cassette (Round Flow with Sensing)	25
FXFQ-A	Ceiling Mounted Cassette (Round Flow)	25
FXZQ-A	Ceiling Mounted Cassette (Compact Multi Flow)	35
FXUQ-A	4-Way Flow Ceiling Suspended	36
FXCQ-A	Ceiling Mounted Cassette (Double Flow)	37
FXXQ-MA	Ceiling Mounted Cassette Corner	39
FXDQ-PD/ND	Slim Ceiling Mounted Duct	41
FXSQ-PA	Middle Static Pressure Ceiling Mounted Duct	43
FXMQ-PA/M	Ceiling Mounted Duct	45
FXHQ-MA/A	Ceiling Suspended	47
FXAQ-A	Wall Mounted	49
FXLQ-MA	Floor Standing	51
FXNQ-MA	Concealed Floor Standing	52
Air Treatment Equipment Lineup	53	
Control Systems	71	
Option List	85	

*VRV is a trademark of Daikin Industries, Ltd.

New Products Information

Heavy Anti-corrosion Model

VRV A MAX RXQ-AW P.15

Maximize Anti-corrosion

Maximize Performance

Maximize Lifespan



► Maximize anti-corrosion and performance

Outer casing

The hot-dip Zinc-Aluminum-Magnesium alloy coated sheet is optimized for even greater durability with an additional four-layer coating combination.

Heat exchanger (Fin)

- The aluminum fins on **VRV A MAX** are manufactured with thicker anti-corrosion layer including an additional two-layer coating.
- New aluminum fins are 21% thicker to maintain performance.
- To prevent differences in coating thickness caused by manual application, the additional fin coatings are performed on the latest automated assembly line, maintaining high precision and quality.

► Maximize lifespan

A third party tested the corrosion resistance (ISO 9227: salt spray tests) of the reinforced fins and casing for ISO 12944: 2018 Category C5 and confirmed them to be at very high (VH) levels.

ISO 12944-6:2018 : Paints and varnishes – Corrosion protection of steel structures by protective paint systems

Category C5 : Industrial areas with high humidity and aggressive atmosphere and coastal areas with high salinity

Level VH : Very high (equivalent to an expected life of 25 years *)

ISO 9227 : Corrosion test in artificial atmospheres-Salt spray tests

* This number of years is not the warranty period of the product. Product life depends on installation location and operating conditions.

The new model resists corrosion by salt, maintains performance, and greatly reduces life cycle costs.

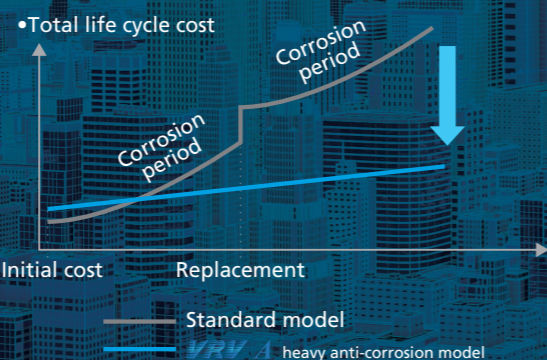

Simplified Remote Controller P.73

Easy operation with new intuitive design

Using only six buttons, users have direct access to basic functions. This enables them to easily set comfort to their preference.



Ceiling Mounted Cassette (Double Flow) Type P.37

Stylish unit blends easily with any interior.

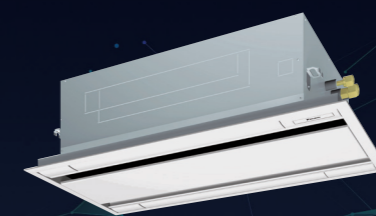

FXCQ-A



- This model features a stylish flat panel with fresh white colour for a new sophisticated appearance.
- Airflow direction can be individually adjusted for each air discharge outlet to deliver optimal air distribution.
- Control of airflow rate has been improved from 3-step to 5-step. Auto airflow rate is newly available.

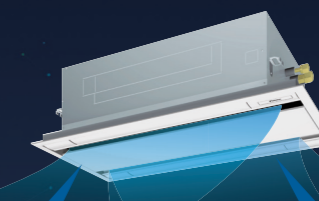

Position 0
(Fixed airflow to highest position)

Swing
(Up / Down)

Ceiling Suspended Type P.47

New 125 / 140 models provide greater capacity for large spaces



FXHQ-A



- The technology of the DC fan motor, wide sirocco fan, and large heat exchanger combine for greater airflow and quiet operation.
- Control of airflow rate has been improved from 2-step to 3-step.

•Suitable for high ceilings

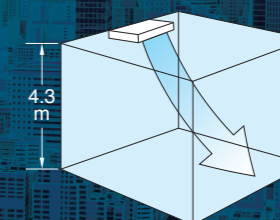

Wall Mounted Type P.49

Stylish flat panel design harmonised with your interior décor

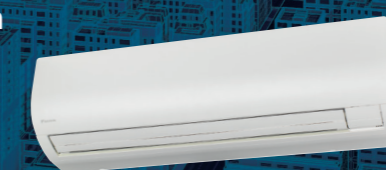

FXAQ-A



- Higher airflow is achieved to enhance comfort.

- Whisper quiet in operation, with sound levels as low as 28.5 dB(A).

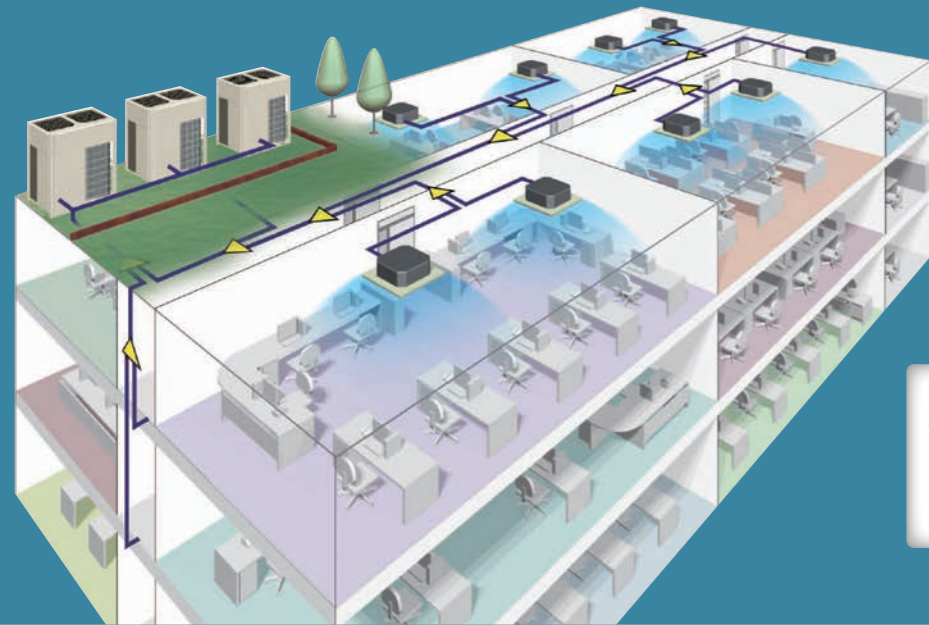

RXQ-A

Cooling Only
6 HP - 48 HP
(16 kW) (135 kW)

Greater energy savings during low-load operation

The key to innovative energy savings is to increase efficiency during low-load operation.

Using data gathered from actual operation, Daikin discovered that air conditioning systems operate at a load factor of 50% or less for 80% of their annual operation period.*

This inspired us to develop new technologies to enhance energy efficiency during low-load operation.

Utilising these technologies, Daikin's new VRV A series raises the standard of energy efficiency.

- * Main factors for frequent operation at low load of 50% or lower
- Because individual control is possible for VRV system, air conditioning is turned OFF to unoccupied rooms such as conference rooms, private rooms, and storage rooms.
- Maximum number of people assumed at the time of design has not been reached.
- There are zones without tenants such as the tenants' office building.

•Correlation between the load factor for the rated capacity and operation time (in office buildings in Singapore)
 *According to a survey by Daikin (based on Air Conditioning Network Service System data)

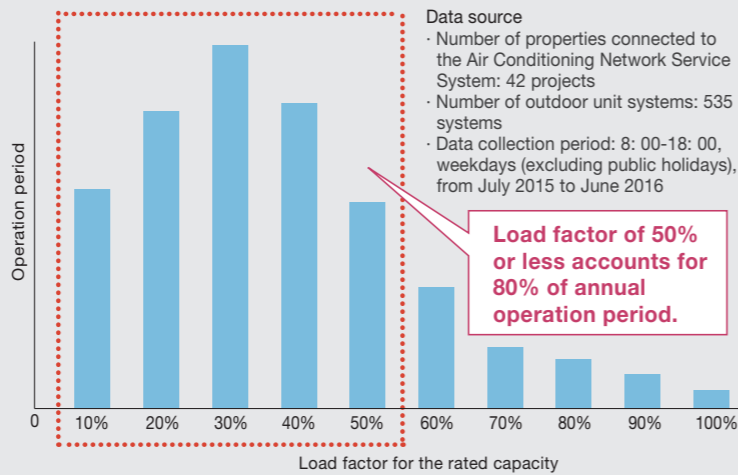

Higher Coefficient of Performance (COP)

COP for 10 HP

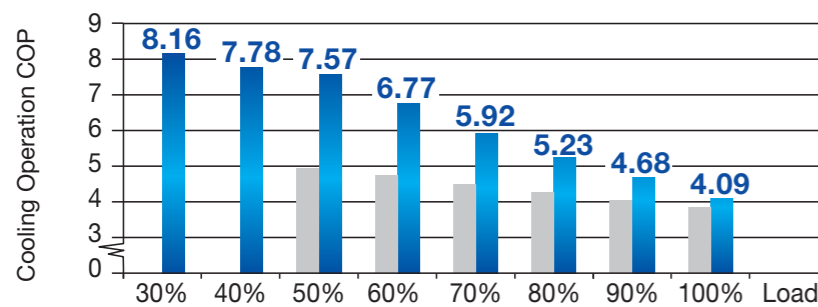

Annual power consumption 14%* lower

- * Simulation conditions :
- Location : Bangkok, Thailand
- System : Outdoor unit (10 HP) x 1
Indoor unit (2 HP, Round Flow with Sensing type) x 5
- Operation time : 8:00-20:00 5 days/week
- Outdoor units :
- New model : RXQ10A (VRV A series)
- Conventional model : RXQ10T (VRV IV)



*Cooling operation conditions: Indoor temp. of 27°CDB, 19°CWB, and outdoor temp. of 35°CDB.

Advanced technologies for greater energy savings

VRV+VRT+VAV

By uniting advanced software and hardware technologies for greater energy savings during actual operation and combining the technologies of VRV, VRT and VAV, we have attained both energy savings and comfortable air conditioning.

VRT Smart Control (Fully Automatic Energy-saving Refrigerant Control)

Software technology

Optimally supply only for the needed capacity of indoor units

Daikin developed VRT smart control by combining air volume control (VAV: Variable Air Volume) for indoor units with conventional VRT control, which optimises compressor speed by calculating the required load for the entire system and optimal target refrigerant temperature based on data sent from each indoor unit. Coordination with the air volume control reduces compressor load and minimises operation loss based on detailed control. VRT smart control ensures energy savings and comfortable air conditioning to meet actual operating conditions.



VRT Smart Control Function movie

Overview of the control (system control flow)

Different automatic energy-saving refrigerant control applies depending on the indoor units connected.

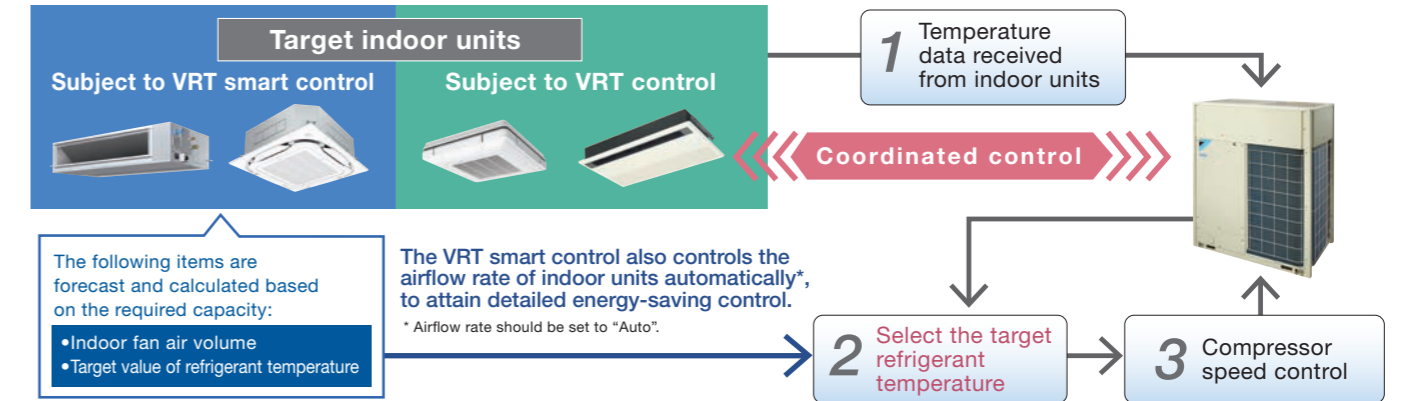

The smooth control (which keeps the compressor running) saves energy and ensures comfort during low-load operation.

Changes in the air-conditioned room temperature during low-load operation*

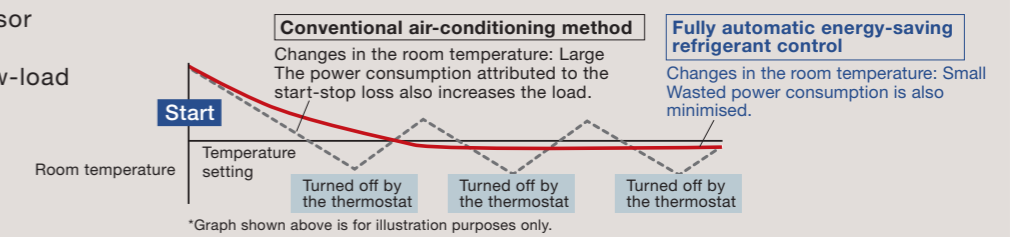

- Note:
- For the classification of indoor units (VRT smart control and VRT control), refer to page 21-22.
 - If a system has indoor units subject to both VRT smart and VRT control, the system is operated under VRT control.
 - If a system has both outdoor-air processing air conditioners and outdoor-air processing type indoor units, VRT smart control and VRT control are disabled.

Optimum utilisation of VRT Smart Control and VRT Control

VRT Smart and VRT control is most effective when all the indoor units operate under low load conditions in a similar manner. Low load conditions are the time when room temperature approaches set temperature. For this reason, please note the following to maximise energy efficiency.

When selecting indoor units

Indoor units are installed in a system so that they operate largely under the same conditions. Energy efficiency decreases for the installation patterns shown below.

Example:

- 1) A load imbalance occurs because an indoor unit in the same system is installed near the perimeter of the room or in the vicinity of a room entrance.
- 2) Different operating hours for indoor units.

Time of Use

1. Energy efficiency decreases when the set temperature of a specified indoor unit is excessively lowered during cooling operation.
2. The airflow rate setting is set to "Auto" during VRT Smart Control.

New Scroll Compressor*

Hardware technology

Refrigerant leakage is minimised during low-load operation.

Operational loss due to refrigerant leakage is reduced with the inclusion of a proprietary back pressure control mechanism to ensure stable low-load operation.



New Scroll Compressor movie

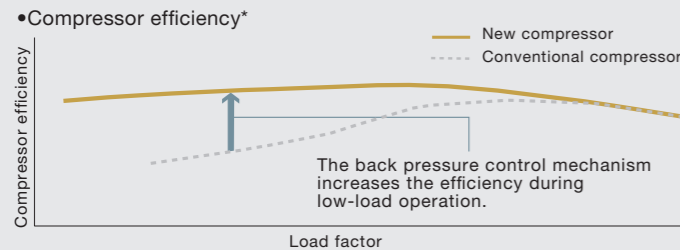

*Graph shown above is for illustration purposes only.

Back pressure control mechanism

Conventional mechanism

The orbiting scroll is engaged by the pressure difference between high and low pressures. The force engaging the orbiting scroll decreases during low-load operation, resulting in compression leakage from movable parts.

New intermediate pressure mechanism

The pressure on the orbiting scroll is optimised according to operating conditions. As a result, the orbiting scroll has been stabilised to increase efficiency during low-load operation.



The force pressing the orbiting scroll decreases during low-load operation.



The intermediate pressure maintains pressure on the orbiting scroll during low-load operation.

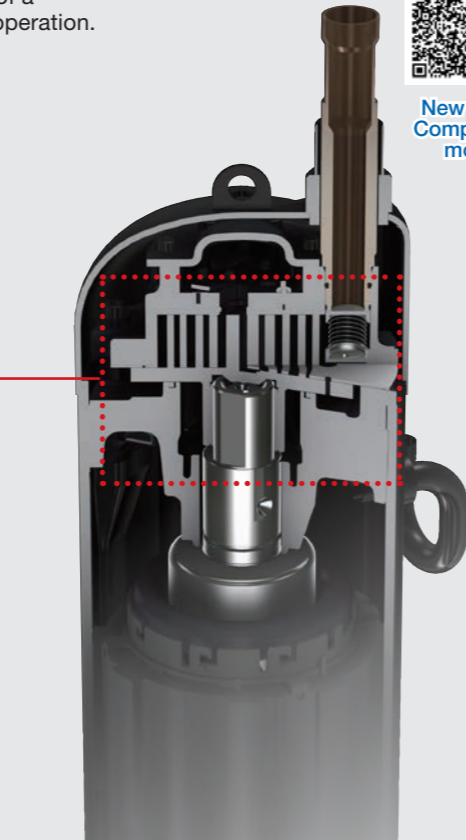

Intermediate pressure adjustment port

The intermediate pressure (back pressure) optimises the pressure on the orbiting scroll depending on the operating condition.

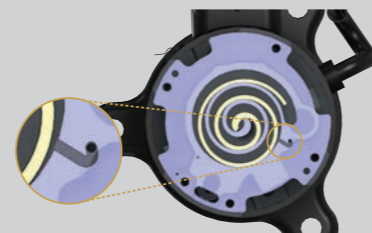

Advanced oil temperature control

Standby power consumption is reduced

The advanced oil temperature control reduces standby power consumption by up to 82.7%* annually compared to conventional models. Standby power needed for preheating refrigerator oil, which consumed substantial standby power, was reduced to save energy when the air conditioner is stopped.

* Operation calculation conditions: VRV A series 14 HP Location: Singapore Operation time: 08:00-18:00 on weekdays.

Automatic refrigerant charge function

Contribute to optimised operation efficiency, higher quality and easier installation



Automatic Refrigerant Charge Function movie

Optimised operation efficiency

The automatic refrigerant charge function automatically determines the optimal amount of refrigerant to be charged. This function prevents a capacity shortage or energy loss due to excessive or insufficient refrigerant.

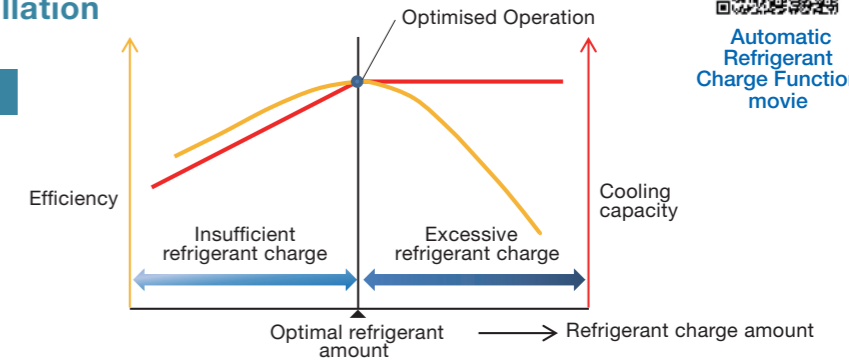

Higher quality and easier installation

The automatic refrigerant charge function automates the charging of the proper refrigerant amount and the closing of shut-off valves by simply pressing a switch after pre-charging. Simplified installation eliminates excessive and insufficient refrigerant charge amounts due to calculation mistakes, and this has led to higher installation quality.

VRV IV

- 1 Calculate necessary refrigerant amount from design drawing
- 2 Recalculate refrigerant amount from final installation drawing
- 3 Charge refrigerant
- 4 Regularly check refrigerant weight on weighing scale
- 5 Complete by manually closing valves when proper weight is reached

VRV A SERIES

- 1 Calculation of necessary refrigerant amount from design drawing
- 2 Pre-charge of refrigerant
- 3 Start of automatic refrigerant charge operation

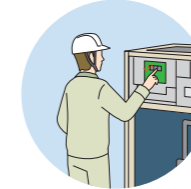
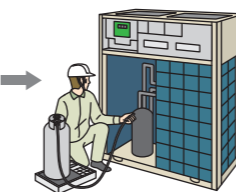

Automatic completion by proper refrigerant amount

Monitoring refrigerant charging is unnecessary

No recalculation of charge amounts due to minor design changes locally

The automatic refrigerant charge operation can also be used again when adding or replacing indoor units or even when changing the layout after installation.

*There are conditions in the range of ambient temperature in which the automatic refrigerant charge can be used. Refer to the installation manual for details.

*Pre-charge amount changes according to conditions, and pre-charging is unnecessary when necessary refrigerant amount is 4 kg and under. Please refer to the installation manual for details.

*The refrigerant amount that can be automatically charged may differ from the additional refrigerant amount that is provided from calculations, but there are no problems in performance and quality.

High reliability

New inverter PC board

The control functions of inverter technology have been integrated on printed circuit boards. As well as improving reliability, this has reduced the number of parts and enabled downsizing.

- New waveform control improves tolerance of variations in power supply voltage. Even if the power supply has irregularities, rises in current are suppressed and operation continues.
- Durability of the inverter printed circuit board improved by changing the electrolytic capacitors for the compressor to film capacitors.

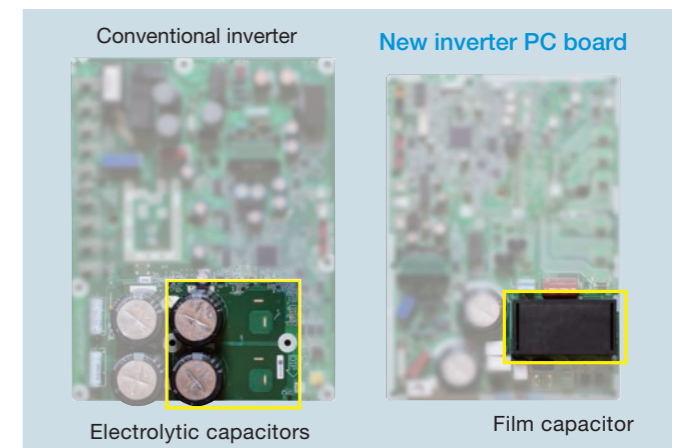

Comfort

Low operation sound

High efficiency heat exchanger helps to achieve low operation sound.

	Sound level(dB(A))			
	6/8 HP	10 HP	12 HP	14/16 HP
VRV A SERIES	56	57	59	60

Large airflow, high static pressure and quiet technology

Advanced analytic technologies are utilised to optimise fan design and increase airflow rate and high external static pressure.

Streamlined air grille

It promotes the discharge of swirling airflow, further reducing pressure loss.



Streamlined scroll fan

The curvature of each fan blade edge reduces both vibration and pressure loss.

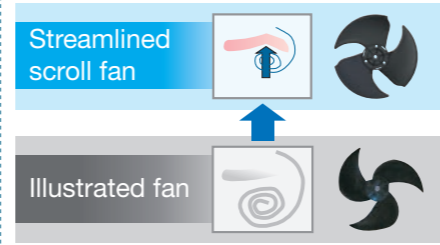

Nighttime quiet operation function

For areas with stringent restrictions placed on outdoor sound levels, the outdoor unit can be set for low operation sound during the nighttime to meet sound restrictions.

The automatic night quiet mode will initiate 8 hours*1 after the peak temperature is reached in the daytime, and normal operation will resume 9 hours*2 after that.

*1. Initial setting is 8 hours. Can be selected from 6, 8 and 10 hours.
 *2. Initial setting is 9 hours. Can be selected from 8, 9 and 10 hours.
 *3. In case of 10 HP outdoor unit.

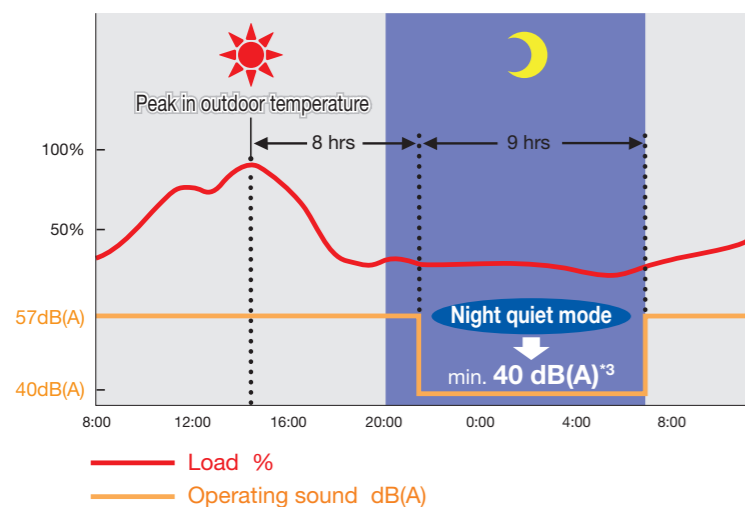

Note:
 · The night quiet mode lowers operating sound by reducing capacity. This function is available in setting at site.
 · The operating sound in quiet operation mode is the actual value measured by our company. Because priority is given to protection mode, such as for oil recovery, the operating sound may become higher temporarily.
 · The relationship of outdoor temperature (load) and time shown above is just an example.

Compact design with high performance

Highly integrated heat exchanger

The unique 4-sided all round heat exchanger ensures sufficient surface area for the heat exchanger. This improves the heat exchanger performance without increasing the footprint.

Waffle Fin
 A waffled-shaped fin with fin pitch of 1.4 mm was adopted to realise sufficient heat exchanger area for optimum unit efficiency.

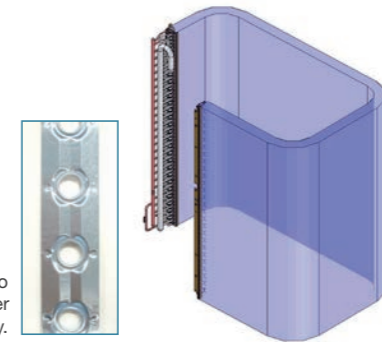

4-sided heat exchanger
 High efficiency heat exchanger is realised by reducing airflow resistance with adoption of small cooling tubes with a diameter of φ7.

Optimised inner design to ensure smooth airflow

Electric components were downsized and positioned in the dead space of the bell mouth side to decrease airflow resistance.

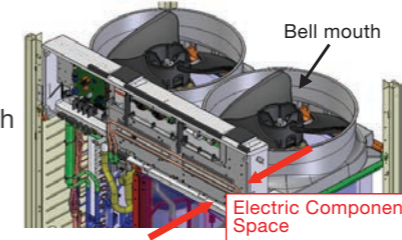

Sufficient cooling for electrical components

The VRV A series is designed with the electrical box strategically positioned between a region of positive and negative pressure. This design allows large airflow from negative pressure to positive pressure due to the high pressure difference.

• High pressure since air enters near the fan blower inlet

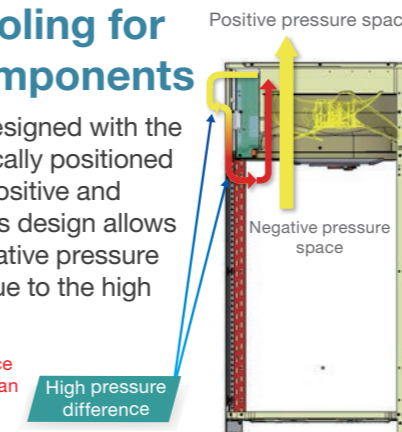

High reliability at high ambient temperatures

It is possible to keep operation stable even at high ambient temperatures by cooling the inverter power module. This helps maintain air-conditioning capacity and reduces failure ratio.

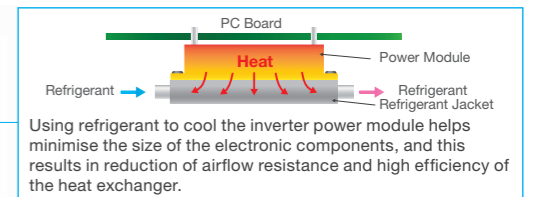
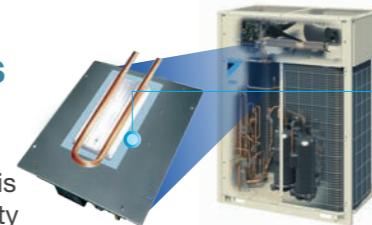

Control board failure ratio at stable operation is reduced.

Outer Rotor DC Motor (ODM)

Only Daikin has adapted an ODM with the feature of stable rotation and volumetric efficiency.

Advantages of ODM

- Thanks to the large diameter of the rotor,
- ① Large torque with same electromagnetic force
- ② Stable rotation in all ranges and can be operated with small number of rotations

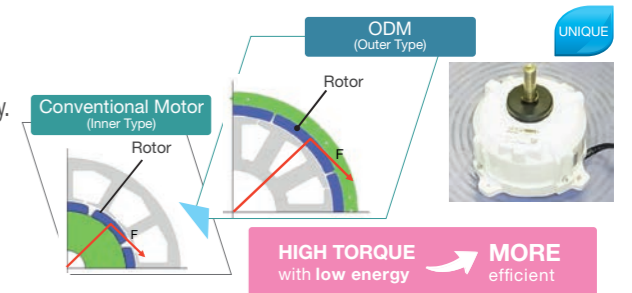

More options for installation location

Long piping length

The long piping length provides more design flexibility, which can match even large-sized buildings.

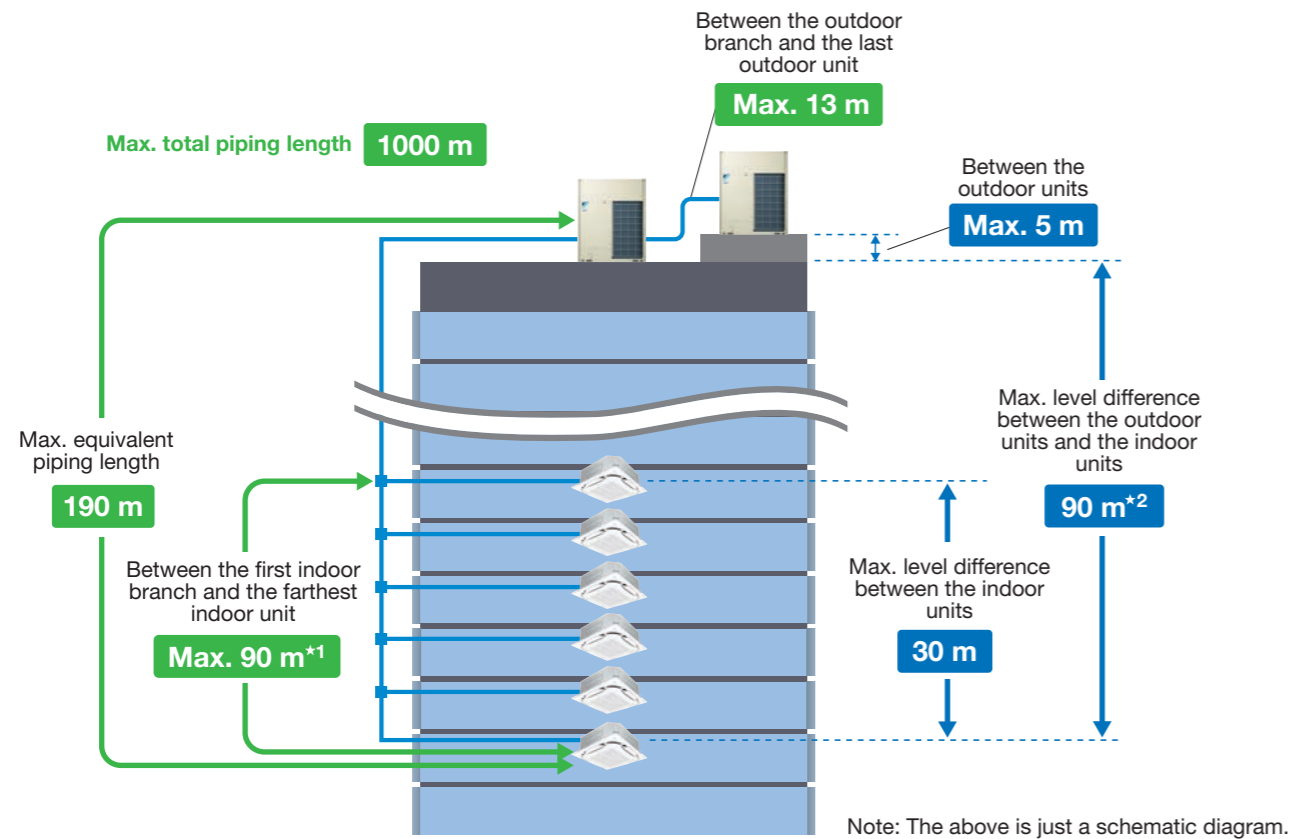

	Actual piping length (Equivalent)	165 m (190 m)
Maximum allowable piping length	Total piping length	1000 m
	Between the first indoor branch and the farthest indoor unit	90 m*1
	Between the outdoor branch and the last outdoor unit (Equivalent)	10 m (13 m)
	Between the outdoor units (Multiple use)	5 m
Maximum allowable level difference	Between the indoor units	30 m
	Between the outdoor units and the indoor units	90 m*2

*1. No special requirements up to 40 m. The maximum actual piping length can be 90 m, depending on conditions. The VRV A series is easy to extend to 90 m by lessening the conditions from conventional VRV IV models. Be sure to refer to the Engineering Data Book for details of these conditions and requirements.
 *2. When level differences are 50 m or more, the diameter of the main liquid piping size must be increased. If the outdoor unit is above the indoor unit, a dedicated setting on the outdoor unit is required. Refer to the Engineering Data Book and contact your local dealer for more information.

Connection ratio

Connection capacity at maximum is 200%.

Connection ratio **50%–200%**

$$\text{Connection ratio} = \frac{\text{Total capacity index of the indoor units}}{\text{Capacity index of the outdoor units}}$$

Conditions of VRV indoor unit connection capacity

Applicable VRV indoor units	FXDQ, FXSQ, FXMQ-PA, FXAQ models	Other VRV indoor unit models*1
Single outdoor units	200%	200%
Double outdoor units		160%
Triple outdoor units		130%

*1 For the FXF(S)Q25 models, maximum connection ratio is 130% for the entire range of outdoor units.
 Note: If the operational capacity of indoor units is more than 130%, low airflow operation is enforced in all the indoor units.
 *Refer to page 18 for outdoor unit combination details.

High external static pressure

VRV A series outdoor unit has been achieved high external static pressure up to 78.4 Pa, ensuring the efficient heat dissipation and stable operation of equipment in either hierarchical or intensive arrangement.



More accurate test operation and stable system

Efficient automatic test operation

Daikin VRV A series incorporates a simplified and efficient test operation function, that not only greatly accelerates the installation process, but also effectively improves the field setting quality.

- Automatically checks the wiring between outdoor units and indoor units to confirm whether there is defective wiring.
- Confirms piping length to optimise operation.
- Automatically checks whether the stop valve in each outdoor unit is functioning normally to ensure the smooth operation of air conditioning system.

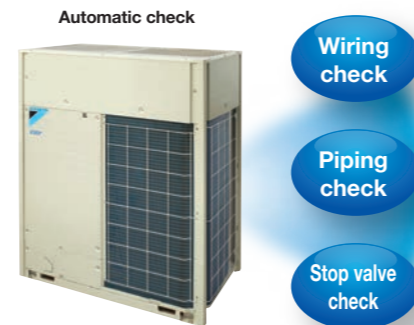

Simplified commissioning and after-sales service

Function of information display by luminous digital tube

VRV A series utilises 7-segment luminous digital tubes to display system operation information, enabling the operational state to be visually displayed whilst facilitating simplified commissioning and after-sales service.

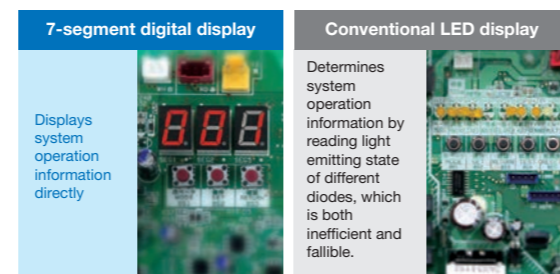

Advanced control main PC board

SMT* packaging technology

- SMT packaging technology adopted by the computer control panel improves the anti-clutter performance.
- Protects your computer boards from the adverse effects of sandy climates and humid weather.

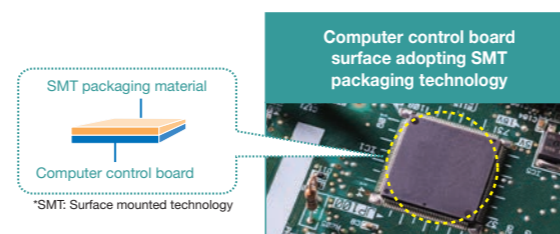

I-demand function

Limit to power consumption can be set precisely to one of 11 levels. Peak power cut-off can be accomplished according to each user situation.

*Set on the circuit board of the outdoor unit.

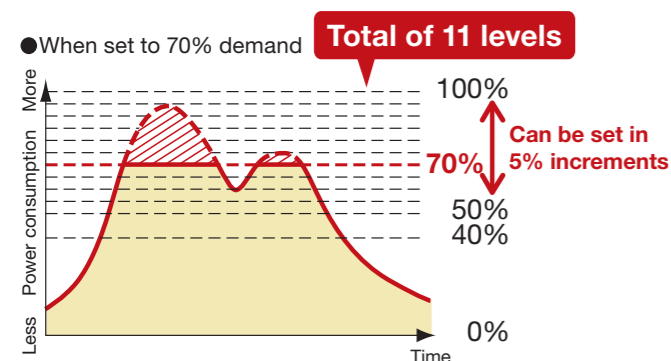

Wide operation temperature range up to 49°C

The versatile operation range of the VRV A series works to reduce limitations on installation locations. The operation temperature range for cooling can be performed with outdoor temperatures as high as 49°C. This enables reliable operation even under high temperature conditions.

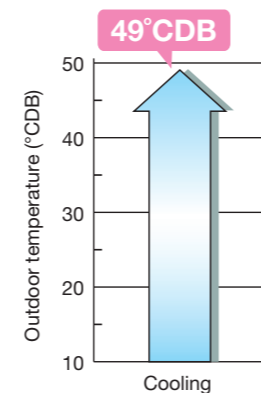

Note: When outdoor temperature falls below 10°C, the thermostat shuts OFF, the outdoor unit stops, and operation switches from cooling to fan operation.

Automatic sequencing operation

During start-up, Daikin VRV A series outdoor unit sequencing operation will be automatically enabled to ensure balance operation of each outdoor unit to improve longevity of equipment and operation stability.

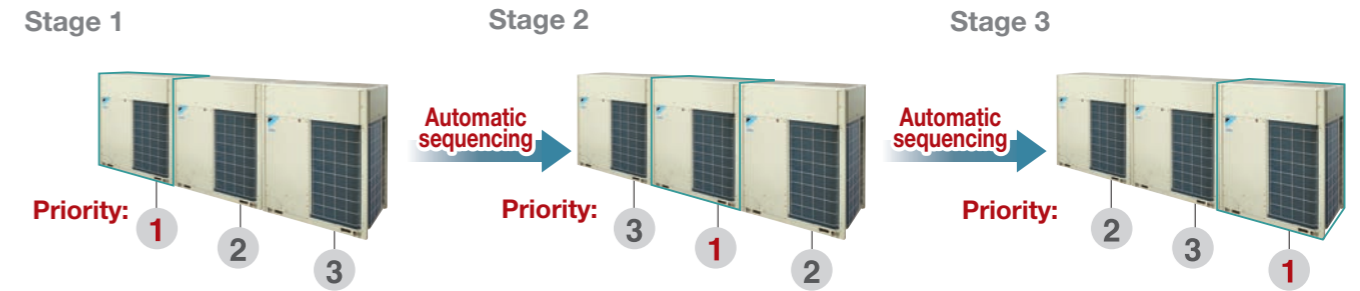

Double backup operation functions

Daikin VRV A series outdoor unit boasts double backup operation functions, which can secure the use of air conditioners in this area to the greatest extent in an emergency by enabling double backup operation functions even if failure occurs in a set of air conditioning equipment. In the event of a failure, emergency operation can be conveniently enabled to allow the remaining system to operate in a limited fashion.

Unit backup operation function

If one of the units in a multiple outdoor system malfunctions, the other outdoor units provide emergency operation until repairs can be made.

* For systems composed of two or more outdoor units.



Compressor backup operation function

The outdoor unit is equipped with two compressors. Even if one compressor malfunctions, the other compressor provides emergency operation, reducing the risk of air conditioning shutdown due to compressor failure. (Capacity is saved during backup operation.)

* For single outdoor unit system RXQ16AYM models. On-site settings are required using the printed circuit board of the outdoor unit.

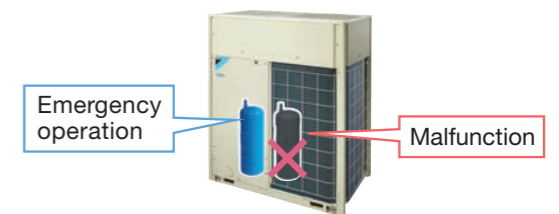

Ease of maintenance

VRV A series provides a maintenance feature* which allows the shutdown of indoor unit without shutting down the whole VRV system. This feature comes in handy during maintenance period as the remaining indoor units continue to operate.

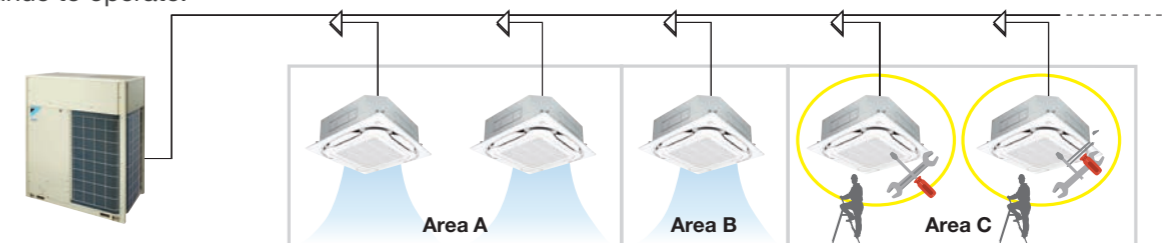

* Field setting is required. This feature does not apply to residential indoor unit connection. For more information, please contact Daikin sales office.

Heavy anti-corrosion model

VRV A MAX

RXQ6-16AYMW
RXQ18-48AMYMNW



Maximize anti-corrosion and performance Outer casing

Multi coating for extreme durability

The hot-dip Zinc-Aluminum-Magnesium alloy coated sheet is optimized for even greater durability with an additional four-layer coating combination.

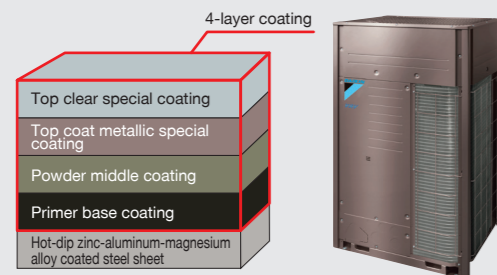

Anti-corrosion verification by accelerated test

Although the previous anti-corrosion model is rusted, the VRV A MAX outer casing shows no signs of corrosion in either test.

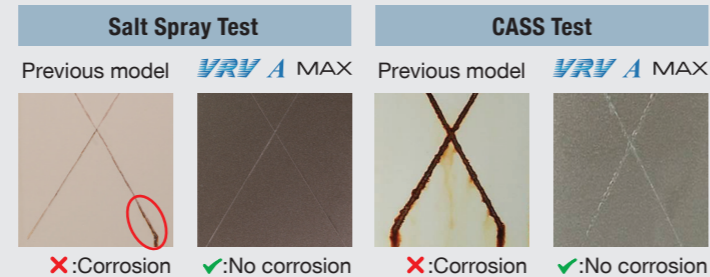

*The cross cut was made in order to simulate a severe case of coating damage and corrosion (not from regular usage).

Heat exchanger (Fin)

Anti-corrosion technology

The aluminum fins on VRV A MAX are manufactured with thicker anti-corrosion layer including an additional two-layer coating.

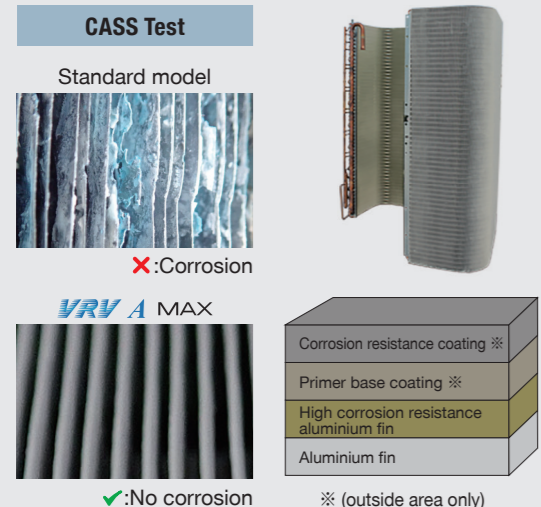

High performance technology

21% thicker aluminum fins

New aluminum fins are 21% thicker to maintain performance.

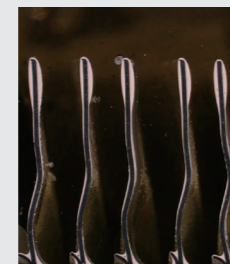

Achieves both anti-corrosion and high efficiency

Automated fin coating line

To prevent differences in coating thickness caused by manual application, the additional fin coatings are performed on the latest automated assembly line, maintaining high precision and quality.

Maximize lifespan

A third party tested the corrosion resistance (ISO 9227: salt spray tests) of the reinforced fins and casing for ISO 12944: 2018 Category C5 and confirmed them to be at very high (VH) levels.

- ISO 12944-6:2018 : Paints and varnishes – Corrosion protection of steel structures by protective paint systems
- Category C5 : Industrial areas with high humidity and aggressive atmosphere and coastal areas with high salinity
- Level VH : Very high (equivalent to an expected life of 25 years *)
- ISO 9227 : Corrosion test in artificial atmospheres-Salt spray tests

* This number of years is not the warranty period of the product. Product life depends on installation location and operating conditions.

The new model resists corrosion by salt, maintains performance, and greatly reduces life cycle costs.

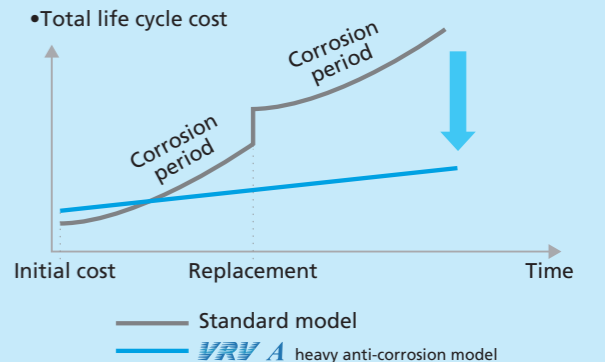

VRV A MAX : Built for seaside

	Previous model	VRV A MAX
Type	Anti-corrosion	Heavy Anti-corrosion for ASEAN
Installation example	<p>The previous generation of anti-corrosion model must be installed at least 300 m away from the sea in a location not in direct contact with sea wind.</p>	<p>VRV A MAX can be installed right by the sea, as long as the unit does not get into contact with seawater, allowing for more flexibility in installation.</p>
Distance	300 - 1,000 m	1,000 m or less

Specifications of anti-corrosion model

Item	Parts	Standard model	VRV A MAX
1	Sheet metal casing Outer casing	Hot dip zinc coated sheet + powder coating	Hot-dip zinc-aluminum-magnesium alloy-coated steel sheet + Primer base coating + Powder middle coating + Top coat metallic special coating (metallic brown) + Top clear special coating
2	Discharge grille • Protection net	Low Density Polyethylene (LDPE) coating	
3	Fasteners	Mild sheet with zinc-nickel plating	SUS410 + zinc-nickel plating + geomet process
4	Heat exchanger	Copper tube + Standard aluminum fin	Copper tube + Anti-corrosion aluminum fin
5	Aluminum fin	Aluminum fin + Hydrophilic anti-corrosion	Aluminum fin + High corrosion resistance aluminum fin + Primer base coating (outside area only) + Corrosion resistance coating (outside area only)
6	Heat exchanger end plate	Hot-dip zinc-aluminum-magnesium alloy-coated steel sheet without coating	Hot dip zinc coated sheet + corrosion resistance polyurethane coating
7	Fan motor stand • Electric box • Inner casing sheet metal	Galvanized iron sheet	Hot dip zinc coated sheet + corrosion resistance polyurethane coating
8	Fan • Fan motor	Resin fan + resin casing motor	
9	Pressure vessel (oil separator)	Hot rolled sheet steel + painting	Hot rolled sheet steel + Double rust inhibitor coating with additional touch-up paint
10	Printed circuit board	Both side resin coating	Expanded both side resin coating

VRV A Series Outdoor Units

The outdoor unit capacity is up to 48 HP (135 kW) in increment of 2 HP.

- VRV A series outdoor unit offers a high capacity of up to 48 HP, responding to the needs of large-sized building.
- The single outdoor unit has only 2 different shapes and dimensions, not only simplifying the design process, but also bringing the system flexibility to a new level.
- With the outdoor unit capacity increased in increment of 2 HP, customers' needs can be precisely met.

Lineup

HP		6	8	10	12	14	16	18	20	22	24	26	28	30	32	34	36	38	40	42	44	46	48	
VRV A SERIES	Single outdoor units	●	●	●	●	●																		
	Double outdoor units							●	●	●	●	●	●	●	●									
	Triple outdoor units																●	●	●	●	●	●	●	●

•Single Outdoor Units

6, 8, 10, 12 HP

14, 16 HP



RXQ6AYM(W)
RXQ8AYM(W)
RXQ10AYM(W)
RXQ12AYM(W)

RXQ14AYM(W)
RXQ16AYM(W)

•Double Outdoor Units

18, 20, 22, 24 HP

26, 28, 30 HP

32 HP



RXQ18AYMN(W)
RXQ20AYMN(W)
RXQ22AYMN(W)
RXQ24AYMN(W)

RXQ26AYMN(W)
RXQ28AYMN(W)
RXQ30AYMN(W)

RXQ32AYMN(W)

•Triple Outdoor Units

34, 36 HP

38, 40, 42 HP



RXQ34AYMN(W) RXQ36AYMN(W)

RXQ38AYMN(W) RXQ40AYMN(W) RXQ42AYMN(W)

44 HP

46, 48 HP



RXQ44AYMN(W)

RXQ46AYMN(W) RXQ48AYMN(W)

Note: Models with (W) are the outdoor units with anti-corrosion specifications. For details, refer to page 15-16 for more information.

Outdoor Unit Combinations

HP	kW	Capacity index	Model name	Combination	Outdoor unit multi connection piping kit ¹	Total capacity index of connectable indoor units ²	Maximum number of connectable indoor units ²
6 HP	16.0	150	RXQ6A	RXQ6A	—	75 to 195 (300)	9 (15)
8 HP	22.4	200	RXQ8A	RXQ8A	—	100 to 260 (400)	13 (20)
10 HP	28.0	250	RXQ10A	RXQ10A	—	125 to 325 (500)	16 (25)
12 HP	33.5	300	RXQ12A	RXQ12A	—	150 to 390 (600)	19 (30)
14 HP	40.0	350	RXQ14A	RXQ14A	—	175 to 455 (700)	22 (35)
16 HP	45.0	400	RXQ16A	RXQ16A	—	200 to 520 (800)	26 (40)
18 HP	50.4	450	RXQ18AM	RXQ8A + RXQ10A	BHFP22P100	225 to 585 (720)	29 (36)
20 HP	55.9	500	RXQ20AM	RXQ8A + RXQ12A		250 to 650 (800)	32 (40)
22 HP	61.5	550	RXQ22AM	RXQ10A + RXQ12A		275 to 715 (880)	35 (44)
24 HP	67.0	600	RXQ24AM	RXQ12A × 2		300 to 780 (960)	39 (48)
26 HP	73.5	650	RXQ26AM	RXQ12A + RXQ14A		325 to 845 (1,040)	42 (52)
28 HP	78.5	700	RXQ28AM	RXQ12A + RXQ16A		350 to 910 (1,120)	45 (56)
30 HP	83.5	750	RXQ30AM	RXQ12A + RXQ18A		375 to 975 (1,200)	48 (60)
32 HP	90.0	800	RXQ32AM	RXQ14A + RXQ18A		400 to 1,040 (1,280)	52 (64)
34 HP	95.0	850	RXQ34AM	RXQ10A + RXQ12A × 2		425 to 1,105 (1,105)	55 (55)
36 HP	101	900	RXQ36AM	RXQ12A × 3		450 to 1,170 (1,170)	58 (58)
38 HP	107	950	RXQ38AM	RXQ12A × 2 + RXQ14A	475 to 1,235 (1,235)	61 (61)	
40 HP	112	1,000	RXQ40AM	RXQ12A × 2 + RXQ16A	BHFP22P151	500 to 1,300 (1,300)	64 (64)
42 HP	117	1,050	RXQ42AM	RXQ12A × 2 + RXQ18A		525 to 1,365 (1,365)	
44 HP	124	1,100	RXQ44AM	RXQ12A + RXQ14A + RXQ18A		550 to 1,430 (1,430)	
46 HP	130	1,150	RXQ46AM	RXQ14A × 2 + RXQ18A		575 to 1,495 (1,495)	
48 HP	135	1,200	RXQ48AM	RXQ14A + RXQ16A + RXQ18A		600 to 1,560 (1,560)	

Note: ¹ For multiple connection, the outdoor unit multi connection piping kit (separately sold) is required.
² Values inside brackets are based on connection of indoor units rated at maximum capacity, 200% for single outdoor units, 160% for double outdoor units, and 130% for triple outdoor units. Refer to page 12 for notes on connection capacity of indoor units.

VRV A Series Outdoor Units

RXQ-A

MODEL		RXQ6AYM(W)	RXQ8AYM(W)	RXQ10AYM(W)	RXQ12AYM(W)	RXQ14AYM(W)	RXQ16AYM(W)	RXQ18AYM(W)	RXQ20AYM(W)	RXQ22AYM(W)	RXQ24AYM(W)								
Combination units		—	—	—	—	—	—	RXQ8AYM(W)	RXQ10AYM(W)	RXQ12AYM(W)	RXQ14AYM(W)								
Power supply		3-phase 4-wire system, 380-415 V/380 V, 50/60 Hz						3-phase 4-wire system, 380-415 V/380 V, 50/60 Hz											
Cooling capacity	Btu/h	54,600	76,400	95,500	114,000	136,000	154,000	172,000	191,000	210,000	229,000								
	kW	16.0	22.4	28.0	33.5	40.0	45.0	50.4	55.9	61.5	67.0								
Power consumption	kW	3.38	5.17	6.84	8.70	10.7	12.9	12.0	13.9	15.5	17.4								
Capacity control	%	25-100	20-100	13-100	12-100	11-100	10-100	7-100	7-100	6-100	6-100								
Casing colour		Ivory white (5Y7.5/1) (Metallic brown *)						Ivory white (5Y7.5/1) (Metallic brown *)											
Compressor	Type	Hermetically sealed scroll type						Hermetically sealed scroll type											
	Motor output	kW	2.3x1	3.4x1	4.5x1	5.6x1	6.4x1	(3.5x1)+(3.5x1)	(3.4x1)+(4.5x1)	(3.4x1)+(5.6x1)	(4.5x1)+(5.6x1)	(5.6x1)+(5.6x1)							
Airflow rate	m ³ /min	119	178	191	257	178+178	178+191	191+191											
Dimensions (HxWxD)	mm	1,657x930x765						(1,657x930x765)+(1,657x930x765)											
Machine weight	kg	175 (180 *)		185 (195 *)		215 (235 *)		260 (280 *)		175+185 (180+195 *)		185+185 (195+195 *)							
Sound level	dB(A)	56		57		59		60		60		61							
Operation range	°CDB	10 to 49						10 to 49											
Refrigerant	Type	R-410A						R-410A											
	Charge	kg	5.9		6.7		6.8		7.4		8.2		5.9+6.7		5.9+6.8		6.7+6.8		6.8+6.8
Piping connections	Liquid	φ9.5 (Brazeing)						φ12.7 (Brazeing)						φ15.9 (Brazeing)					
	Gas	φ19.1 (Brazeing)		φ22.2 (Brazeing)		φ28.6 (Brazeing)		φ28.6 (Brazeing)						φ34.9 (Brazeing)					

MODEL		RXQ26AYM(W)	RXQ28AYM(W)	RXQ30AYM(W)	RXQ32AYM(W)	RXQ34AYM(W)	RXQ36AYM(W)	RXQ38AYM(W)	RXQ40AYM(W)	RXQ42AYM(W)	RXQ44AYM(W)	RXQ46AYM(W)	RXQ48AYM(W)
Combination units		RXQ12AYM(W)	RXQ12AYM(W)	RXQ12AYM(W)	RXQ14AYM(W)	RXQ10AYM(W)	RXQ12AYM(W)	RXQ12AYM(W)	RXQ12AYM(W)	RXQ12AYM(W)	RXQ12AYM(W)	RXQ14AYM(W)	RXQ14AYM(W)
Power supply		3-phase 4-wire system, 380-415 V/380 V, 50/60 Hz						3-phase 4-wire system, 380-415 V/380 V, 50/60 Hz					
Cooling capacity	Btu/h	251,000	268,000	285,000	307,000	324,000	345,000	365,000	382,000	399,000	423,000	444,000	461,000
	kW	73.5	78.5	83.5	90.0	95.0	101	107	112	117	124	130	135
Power consumption	kW	19.4	21.6	24.0	26.0	24.2	26.1	28.1	30.3	32.7	34.7	36.7	38.9
Capacity control	%	6-100	5-100	5-100	5-100	4-100	4-100	4-100	4-100	4-100	3-100	3-100	3-100
Casing colour		Ivory white (5Y7.5/1) (Metallic brown *)						Ivory white (5Y7.5/1) (Metallic brown *)					
Compressor	Type	Hermetically sealed scroll type						Hermetically sealed scroll type					
	Motor output	kW	(5.6x1)+(6.4x1)	(5.6x1)+(3.5x1)+(3.5x1)	(5.6x1)+(4.0x1)+(4.0x1)	(6.4x1)+(4.0x1)+(4.0x1)	(4.5x1)+(5.6x1)+(5.6x1)	(5.6x1)+(5.6x1)+(5.6x1)	(5.6x1)+(5.6x1)+(6.4x1)	(5.6x1)+(5.6x1)+(3.5x1)+(3.5x1)	(5.6x1)+(5.6x1)+(4.0x1)+(4.0x1)	(5.6x1)+(6.4x1)+(4.0x1)+(4.0x1)	(6.4x1)+(6.4x1)+(4.0x1)+(4.0x1)
Airflow rate	m ³ /min	191+257		257+257		178+191+191		191+191+191		191+191+257		191+257+257	
Dimensions (HxWxD)	mm	(1,657x930x765)+(1,657x1,240x765)				(1,657x1,240x765)+(1,657x1,240x765)		(1,657x930x765)+(1,657x930x765)+(1,657x1,240x765)				(1,657x930x765)+(1,657x1,240x765)+(1,657x1,240x765)	
Machine weight	kg	185+215 (195+235 *)		185+260 (195+280 *)		215+260 (235+280 *)		185+185+185 (195+195+195 *)		185+185+215 (195+195+235 *)		185+185+260 (195+195+280 *)	
Sound level	dB(A)	63		64		63		64		64		65	
Operation range	°CDB	10 to 49						10 to 49					
Refrigerant	Type	R-410A						R-410A					
	Charge	kg	6.8+7.4		6.8+8.2		6.8+8.4		7.4+8.4		6.7+6.8+6.8		6.8+6.8+6.8
Piping connections	Liquid	φ19.1 (Brazeing)						φ19.1 (Brazeing)					
	Gas	φ34.9 (Brazeing)				φ41.3 (Brazeing)		φ41.3 (Brazeing)					

Note: Specifications are based on the following conditions;

- Cooling: Indoor temp.: 27°CDB, 19°CWB, Outdoor temp.: 35°CDB, Equivalent piping length: 7.5 m, Level difference: 0 m.
- Sound level: Anechoic chamber conversion value, measured at a point 1 m in front of the unit at a height of 1.5 m.

During actual operation, these values are normally somewhat higher as a result of ambient conditions and oil recovery mode.

When there is concern for noise to the surrounding area such as residences, we recommend investigating the installation location and taking soundproofing measures.

Note: *1. Models with (W) are the outdoor units with anti-corrosion specifications. For details, refer to page 15-16 for more information.

Enhanced range of choices

Type	Model Name	Capacity Range	VRV smart Indoor units subject to VRT smart control										VRT Indoor units subject to VRT control								
			0.8 HP	1 HP	1.25 HP	1.6 HP	2 HP	2.5 HP	3 HP	3.2 HP	4 HP	5 HP	6 HP	8 HP	10 HP						
			Capacity Index	20	25	31.25	40	50	62.5	71	80	100	125	140	200	250					
Ceiling Mounted Cassette (Round Flow with Sensing)	FXFSQ-AVM			●	●	●	●	●		●	●	●	●								
Ceiling Mounted Cassette (Round Flow)	FXFQ-AVM			●	●	●	●	●		●	●	●	●								
Ceiling Mounted Cassette (Compact Multi Flow)	FXZQ-AVM		●	●	●	●	●														
4-Way Flow Ceiling Suspended	FXUQ-AVEB									●		●									
Ceiling Mounted Cassette (Double Flow)	FXCQ-AVM		●	●	●	●	●	●		●		●									
Ceiling Mounted Cassette Corner	FXKQ-MAVE			●	●	●	●														
Slim Ceiling Mounted Duct	FXDQ-PDVE (with drain pump)		●	●	●																
	FXDQ-PDVET (without drain pump)		●	●	●																
	FXDQ-NDVE (with drain pump)					●	●	●													
	FXDQ-NDVET (without drain pump)		●	●	●	●	●	●													
Middle Static Pressure Ceiling Mounted Duct	FXSQ-PAVE		●	●	●	●	●	●		●	●	●	●								
Ceiling Mounted Duct	FXMQ-PAVE		●	●	●	●	●	●		●	●	●	●								
	FXMQ-MVE9																●	●			
Outdoor-Air Processing Unit	FXMQ-MFV1																		●	●	
Ceiling Suspended	FXHQ-MAVE				●							●									
	FXHQ-AVM													●	●						
Wall Mounted	FXAQ-AVM		●	●	●	●	●	●													
Floor Standing	FXLQ-MAVE		●	●	●	●	●	●													
Concealed Floor Standing	FXNQ-MAVE		●	●	●	●	●	●													
Heat Reclaim Ventilator with DX-Coil	VKM		Airflow rate 500-1000 m³/h																		
Heat Reclaim Ventilator	VAM		Airflow rate 150-2000 m³/h																		

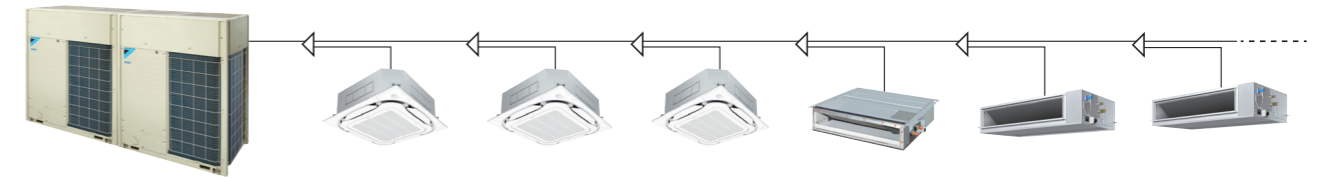

Max. 64 indoor units

- If a system has indoor units subject to both VRT smart and VRT control, the system is operated under VRT control.
- If a system has both outdoor-air processing air conditioners and outdoor-air processing type indoor units, VRT smart control and VRT control are disabled.

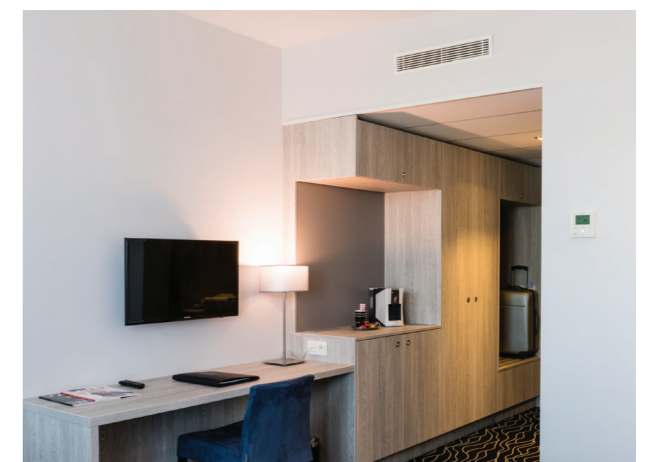
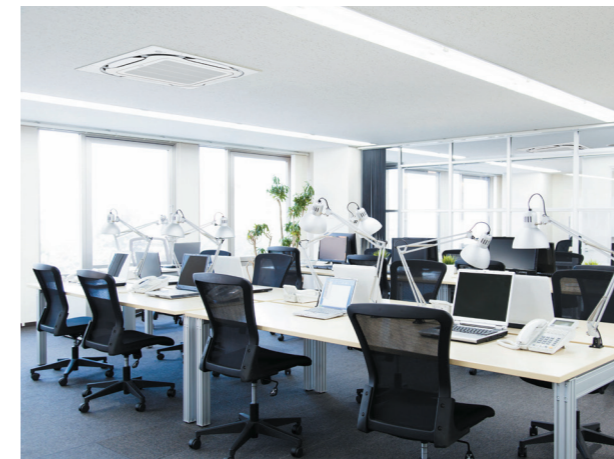

Indoor Unit Lineup

Daikin offers a wide range of indoor units responding to variety of needs of our customers that require air-conditioning solutions.

VRV indoor units

Ceiling Mounted Cassette (Round Flow with Sensing) Type **P.25**

FXFSQ-AVM

Presence of people and floor temperature can be detected to provide comfort and energy savings.

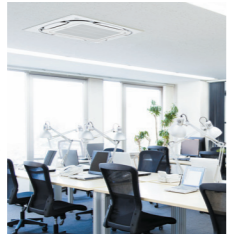

Ceiling Mounted Cassette (Round Flow) Type **P.25**

FXFQ-AVM

360° airflow improves temperature distribution and offers a comfortable living environment.

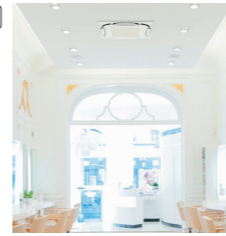

Ceiling Mounted Cassette (Compact Multi Flow) Type **P.35**

FXZQ-AVM

Quiet, compact, and designed for user comfort.



4-Way Flow Ceiling Suspended Type **P.36**

FXUQ-AVEB

Slim and stylish design, optimum air distribution, installation without ceiling cavity.

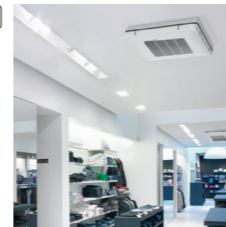

Ceiling Mounted Cassette (Double Flow) Type **P.37**

FXCQ-AVM

Sophisticated panel design blends easily with any interior.

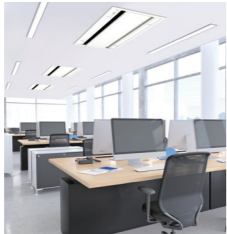

Ceiling Mounted Cassette Corner Type **P.39**

FXKQ-MAVE

Slim design for flexible installation

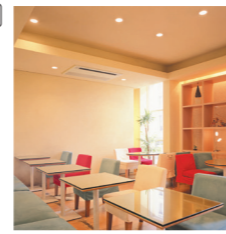
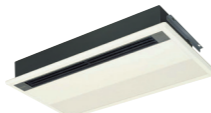

Slim Ceiling Mounted Duct Type **P.41**

FXDQ-PDVE(T)

FXDQ-NDVE(T)

Slim design, quietness and static pressure switching.

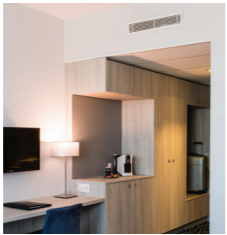

Middle Static Pressure Ceiling Mounted Duct Type **P.43**

FXSQ-PAVE

Middle static pressure and slim design allow flexible installations.

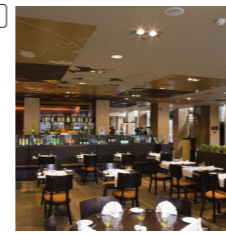

Ceiling Mounted Duct Type **P.45**

FXMQ-PAVE

FXMQ-MVE9

Middle and high static pressure allows for flexible duct design.



Outdoor-Air Processing Unit **P.55**

FXMQ-MFV1

Combine fresh air treatment and air conditioning, supplied from a single system.

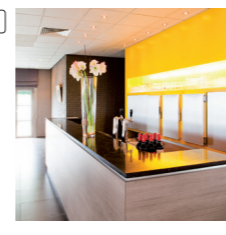

Ceiling Suspended Type **P.47**

FXHQ-MAVE

FXHQ-AVM

Slim body with quiet and wide airflow.



Wall Mounted Type **P.49**

FXAQ-AVM

Stylish flat panel design harmonised with your interior décor.



Floor Standing Type **P.51**

FXLQ-MAVE

Suitable for perimeter zone air conditioning.



Concealed Floor Standing Type **P.52**

FXNQ-MAVE

Designed to be concealed against the wall.



Air treatment equipment

Heat Reclaim Ventilator with DX-Coil

VKM



P.59

Heat Reclaim Ventilator

VAM

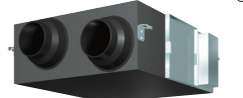

P.63

Ceiling Mounted Cassette (Round Flow with Sensing) Type

Ceiling Mounted Cassette (Round Flow) Type

FXFSQ-A
Round flow with sensing



FXFQ-A
ROUND FLOW

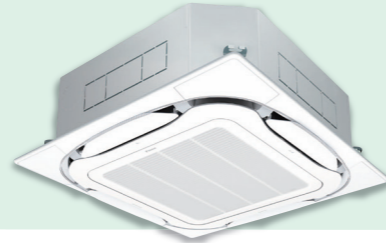

Wide variety of decoration panels (Option)

● Designer choice has been given a boost with the increase in number of new types of decoration panels.



FXFSQ series only
Standard panel with sensing



- Black -



Designer panel



- Fresh White -



Standard panel

Designer panel (Option)

Close to ideal styling

New designer panel

FLAT

Flatter styling:
Suction panel grid texture smoothed.

CLEAN

Clean-cut form:
Soiling is hard to see on smart-looking panel.

ROUND

Subtle distinction:
around suction inlets silvering is a tasteful touch.

Decoration Panel Lineup (Option)



FXFSQ series only
Standard panel with sensing^{**1}
BYCQ125EEF (Fresh White)



Standard panel^{**2}
BYCQ125EAF (Fresh White)



Designer panel^{**2}
BYCQ125EAPF (Fresh White)



Auto grille panel^{**2}
BYCQ125EBSF (Fresh White)

^{**1}.Sensing function is applicable when sensing panel is installed.
^{**2}.These panels do not contain the sensing function.

Specifications

Ceiling Mounted Cassette (Round Flow with Sensing) Type

MODEL	FXFSQ25AVM	FXFSQ32AVM	FXFSQ40AVM	FXFSQ50AVM	FXFSQ63AVM	FXFSQ80AVM	FXFSQ100AVM	FXFSQ125AVM	FXFSQ140AVM	
Power supply	1-phase, 220-240 V/220-230 V, 50/60 Hz									
Cooling capacity	Btu/h	9,600	12,300	15,400	19,100	24,200	30,700	38,200	47,800	54,600
	kW	2.8	3.6	4.5	5.6	7.1	9.0	11.2	14.0	16.0
Power consumption	kW	0.028		0.035	0.056	0.061	0.092	0.164	0.170	0.194
Casing	Galvanised steel plate									
Airflow rate (H/HM/M/ML/L)	m ³ /min	13/12.5/11.5/11/10		17/13.5/12.5/12/11	23/20.5/19/14.5/11	23.5/21/20/16/13.5	24.5/22/20.5/20/15	33.5/30.5/27/23.5/21	34.5/31.5/28.5/25.5/23	35.5/32.5/29.5/26.5/23
	cfm	459/441/406/388/353		600/477/459/424/388	812/724/671/512/388	830/741/706/565/477	865/777/724/706/530	1,183/1,077/953/830/741	1,218/1,112/1,006/900/812	1,253/1,147/1,041/935/812
Sound level (H/HM/M/ML/L)	dB(A)	30/29.5/28.5/28/27		35/29.5/29/28/27	38/35/34.5/29.5/27	38/36/35.5/31.5/28	39/37/36/35.5/31	44/41/38/35/33	45/42.5/39.5/37/35	46/43.5/40.5/38/35
Dimensions (H×W×D)	mm	256×840×840						298×840×840		
Machine weight	kg	19			24	22		25		26
Piping connections	Liquid (Flare)	φ 6.4				φ 9.5				
	Gas (Flare)	φ 12.7				φ 15.9				
	Drain	VP25 (External Dia. 32/Internal Dia. 25)								

Ceiling Mounted Cassette (Round Flow) Type

MODEL	FXFQ25AVM	FXFQ32AVM	FXFQ40AVM	FXFQ50AVM	FXFQ63AVM	FXFQ80AVM	FXFQ100AVM	FXFQ125AVM	FXFQ140AVM	
Power supply	1-phase, 220-240 V/220-230 V, 50/60 Hz									
Cooling capacity	Btu/h	9,600	12,300	15,400	19,100	24,200	30,700	38,200	47,800	54,600
	kW	2.8	3.6	4.5	5.6	7.1	9.0	11.2	14.0	16.0
Power consumption	kW	0.029		0.036	0.040	0.063	0.096	0.158	0.178	0.203
Casing	Galvanised steel plate									
Airflow rate (H/HM/M/ML/L)	m ³ /min	13/12.5/11.5/11/10		17/13.5/13/12/11	18/17/13.5/12.5/11	21/20/16/15/13.5	22.5/21.5/21/20/15	32/29/26/23/21	33/30.5/28/25/21	35.5/32.5/29.5/26.5/23
	cfm	459/441/406/388/353		600/477/459/424/388	635/600/477/441/388	741/706/565/530/477	794/759/741/706/530	1,130/1,024/918/812/741	1,165/1,077/988/900/741	1,253/1,147/1,041/935/812
Sound level (H/HM/M/ML/L)	dB(A)	30/29.5/28.5/28/27		35/29.5/29/28/27	35/33.5/29.5/28.5/27	36/35.5/31.5/31/28	37/36.5/36/35.5/29.5	43/40.5/37.5/35/33	44/41.5/39/36.5/33	46/43.5/40.5/38/35
Dimensions (H×W×D)	mm	256×840×840						298×840×840		
Machine weight	kg	19			22		25		26	
Piping connections	Liquid (Flare)	φ 6.4				φ 9.5				
	Gas (Flare)	φ 12.7				φ 15.9				
	Drain	VP25 (External Dia. 32/Internal Dia. 25)								

Note: Specifications are based on the following conditions:

- Cooling: Indoor temp.: 27°CDB, 19°CWB, Outdoor temp.: 35°CDB, Equivalent piping length: 7.5 m, Level difference: 0 m.
- Capacity of indoor unit is only for reference. Actual capacity of indoor unit is based on the total capacity index. (See Engineering Data Book for details.)
- Sound level: Anechoic chamber conversion value, measured at a point 1.5 m downward from the unit centre. During actual operation, these values are normally somewhat higher as a result of ambient conditions.

Decoration Panel (Option)

	Round Flow with Sensing Type		Round Flow Type	
	FXFSQ-A		FXFQ-A	
Standard panel with sensing	BYCQ125EEF (Fresh White) / BYCQ125EEK (Black)		-	
Dimensions(H×W×D)	mm		50×950×950	
Weight	kg		5.5	
Standard panel	BYCQ125EAF (Fresh White) / BYCQ125EAK (Black)		-	
Dimensions(H×W×D)	mm		50×950×950	
Weight	kg		5.5	
Designer panel	BYCQ125EAPF (Fresh White)		-	
Dimensions(H×W×D)	mm		97×950×950	
Weight	kg		6.5	
Auto grille panel	BYCQ125EBSF (Fresh White)		-	
Dimensions(H×W×D)	mm		105×950×950	
Weight	kg		8	

Function List

	Round Flow with Sensing Type		Round Flow Type	
	FXFSQ-A		FXFQ-A	
Remote controller	Wired	BRC1E63	BRC1E63	-
	Wireless	-	-	BRC7M635F(K)
Dual sensors ^{**1}	○		○	
Direct airflow ^{**1}	○		○	
Sensing sensor low mode ^{**1}	○		○	
Sensing sensor stop mode ^{**1}	○		○	
Circulation airflow	○		○	
Individual airflow direction control	○		○	
Switchable 5 step fan speed	○		○	
Auto airflow rate	○		○	
Auto swing	○		○	
Swing pattern selection	○		○	
High ceiling application	○		○	

^{**1}. Applicable when sensing panel is installed.

Daikin Advanced Sensing Functions^{*1,2} **FXFSQ series only**

Ceiling Mounted Cassette (Round Flow with Sensing) Type **FXFSQ-A**

Dual Sensors^{*1}

*1. Applicable when sensing panel (BYCQ125EEF/EEK) is installed.
*2. Applicable when wired remote controller BRC1E63 is used.

Dual sensors and individual airflow direction control automatically provide optimal control of airflow.

Infrared presence sensor

The sensor detects the presence of people in each of the 4 areas.

Ceiling height	2.7m	3.5m	4.0m
Detection range (diameter) ^{*3}	approx. 8.5m	approx. 11.5m	approx. 13.5m

*3. The infrared presence sensor detects 80cm above the floor.

Infrared floor sensor

The sensor detects the floor temperature and automatically adjusts operation of the indoor unit to reduce the temperature difference between the ceiling and the floor.

Ceiling height	2.7m	3.5m	4.0m
Detection range (diameter) ^{*4}	approx. 11m	approx. 14m	approx. 16m

*4. The infrared floor sensor detects at the floor surface.

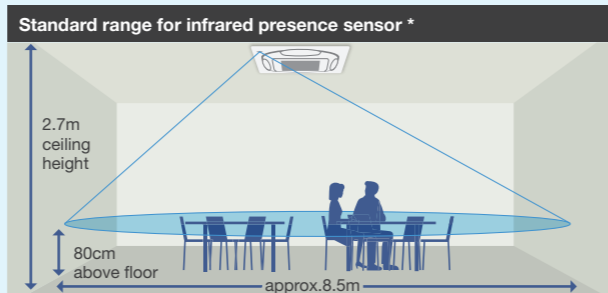

[Concerning infrared presence sensor]
- People are detected by large movements such as the motion of people walking at a certain distance away from sensor.
- Human detection is not possible for blind areas of sensor.
[Concerning infrared floor sensor]
- The detected temperature may sometimes be affected by a heat source, window, or device emitting heat in the detection range.

*5. Airflow direction should be set to "Auto".

Auto Airflow Function^{*5}

Direct Airflow (default: OFF) **Cooling** **Dry**

When human presence is not detected

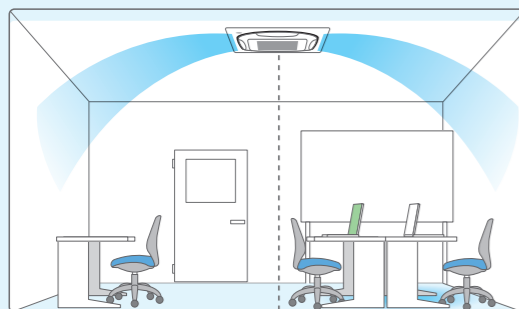

Optimal air direction by "Auto"

When human presence is detected



Optimal air direction by "Auto" **Swing (narrow)**

• With "Auto" airflow direction mode, flaps are controlled to deliver optimal airflow when the room is unoccupied.

• When presence is detected, air direction is set to "Swing (narrow)" to deliver cool air to users.

Comfort and Energy Saving Preventing Overcooling^{*6}

*6. Airflow direction and airflow rate should be set to "Auto".

Floor temperature is detected and overcooling prevented. **Cooling**

Without sensing function

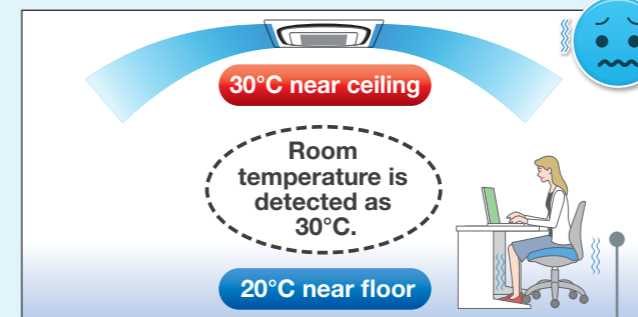

Area around feet gets too cold because the air conditioner continues until the temperature near the ceiling reaches the set temperature.

With sensing function

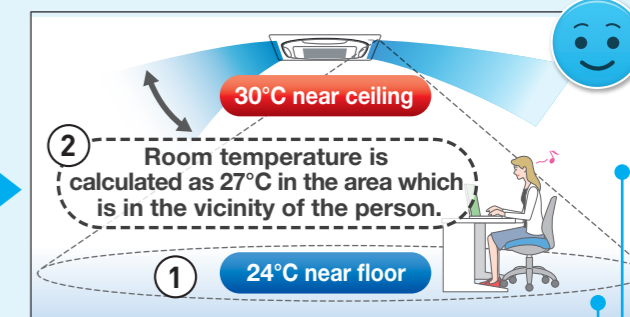

The floor temperature, which is lower than near the ceiling, is detected.

Automatic control using the temperature near the person as the room temperature.

Energy savings

The temperature near the person is automatically calculated by detecting the temperature of the floor. Energy is saved because the area around the feet does not get too cold.

Sensing Sensor Functions^{*7,8,9}

*7. Applicable when sensing panel (BYCQ125EEF/EEK) is installed.
*8. These functions are not available when using the group control system.
*9. User can set these functions with remote controller.

Sensing sensor low mode (default: OFF)

When there are no people in a room, the set temperature is shifted automatically.

- The system automatically saves energy by detecting whether or not the room is occupied. The set temperature is shifted automatically if the room is unoccupied.

Operation is reduced in places where there are no people.

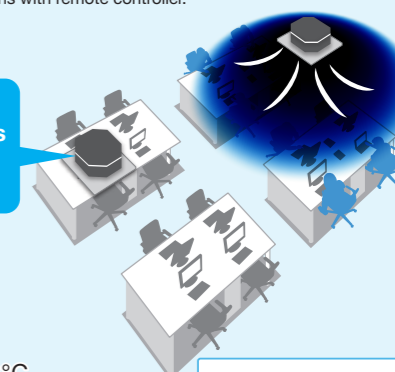

Example • Cooling set temperature: 26°C • Shift temperature: 1.0°C
• Shift time: 30 min. • Limit cooling set temperature: 30°C

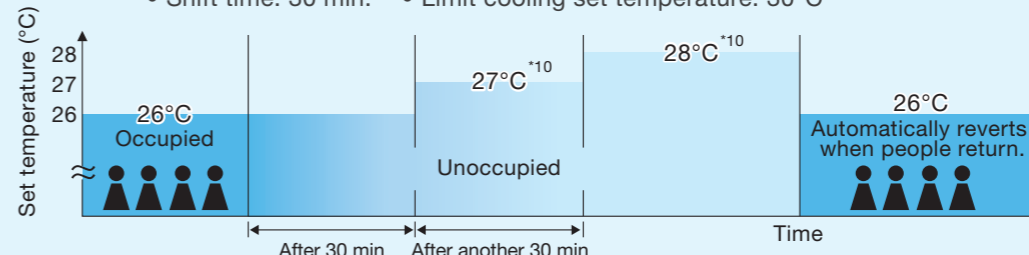

If people do not return, the air conditioner will raise the set temperature 1°C every 30 minutes and then operate at 30°C.

Shift temperature and time can be selected from 0.5 to 4°C in 0.5°C increments and 15, 30, 45, 60, 90 or 120 minutes respectively with remote controller.

*10. On basic screen of remote controller, set temperature does not change.

Sensing sensor stop mode (default: OFF)

When there are no people in a room, the system stops automatically.^{*11,12}

- The system automatically saves energy by detecting whether or not the room is occupied.
- Based on preset user conditions, the system automatically stops operation if the room is unoccupied.

Absent stop time can be selected from 1 to 24 hrs in 1 hr increments with remote controller.

*11. Please note that upon re-entering the room, the air conditioner will not switch on automatically.
*12. To protect the machine, the standby system may operate temporarily.



Circulation Airflow^{*1}

*1. Applicable when wired remote controller BRC1E63 is used.

Airflow until now had areas that were either too cool or not cool enough. 😞

- Problem 1**
Hot outdoor air entering through windows and walls causes these areas to become hot.
- Problem 2**
Cool air accumulating directly underneath causes cold air pockets at floor level.
- Problem 3**
Airflow blowing directly on people causes discomfort for people in the room.
- Problem 4**
Quick descent of cool air causes insufficient cooling for corners of the room.

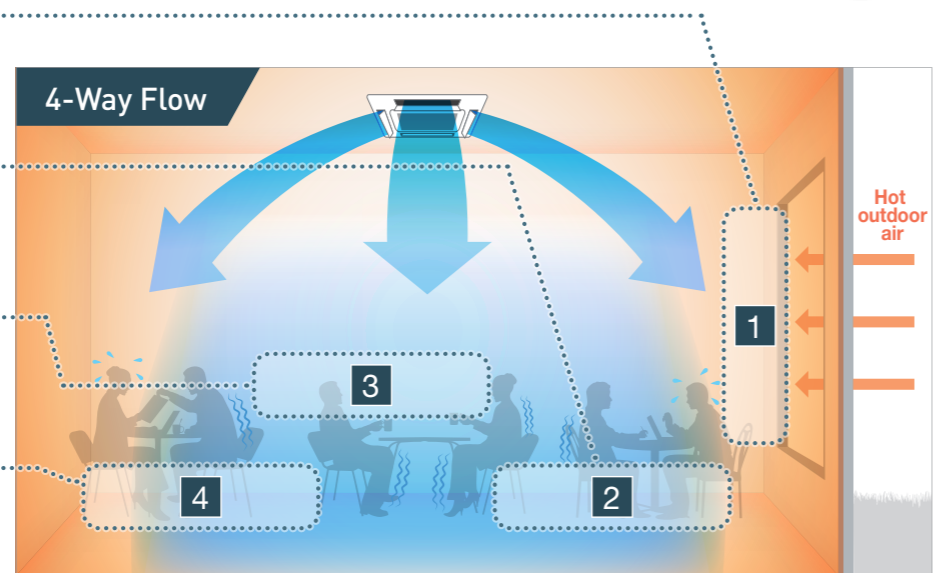

Circulation airflow cools the entire room to deliver comfort that never feels cold. 😊

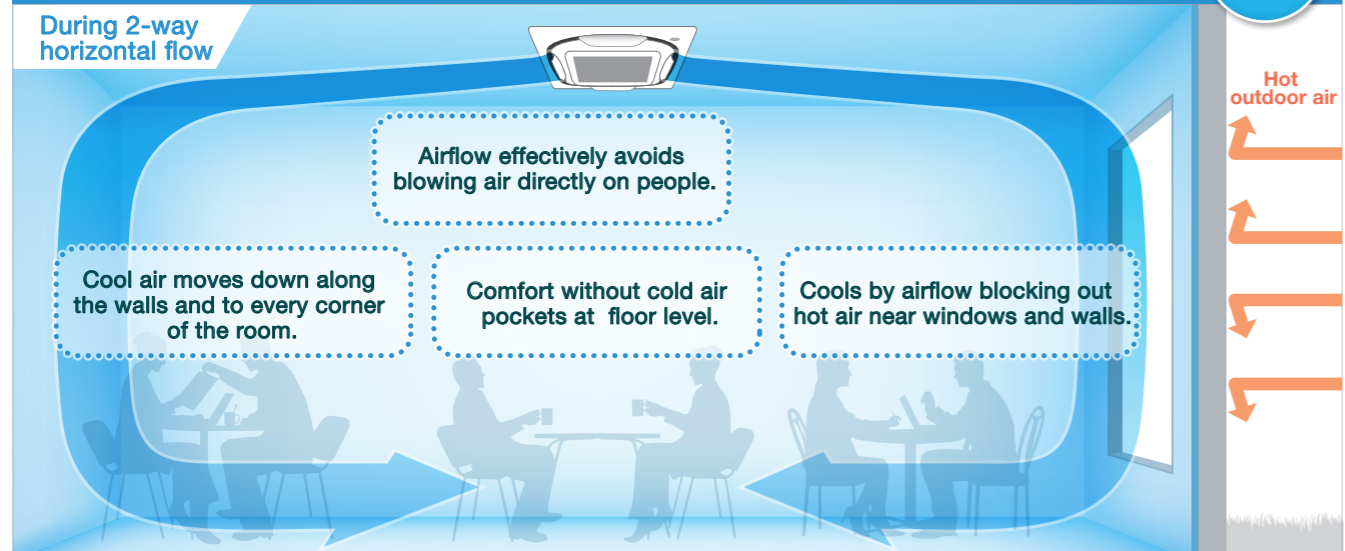

Configurations of Circulation Airflow

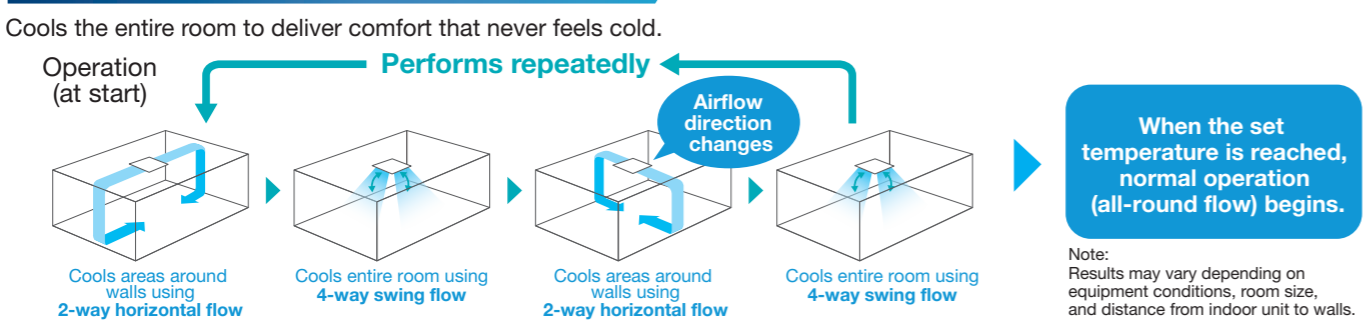

Ceiling Mounted Cassette (Round Flow with Sensing) Type **FXFSQ-A** Ceiling Mounted Cassette (Round Flow) Type **FXFQ-A**

Comfort to the Entire Room with Even Temperatures and No Cold Air Pockets at Floor Level

Comparison Conditions

- Room size: Width 7.5m x depth 7.5m x height 2.6m
- Indoor unit capacity: 80 class
- Outdoor air temperature: 35°C
- Airflow rate and air direction: high / swing

Areas at floor level are cold while areas around walls are hot.

Approx. 5% energy savings^{*2} by reducing uneven temperatures

*2. Calculated under the following comparison conditions: When the average temperature at a height of 0.6m above the floor reaches set temperature. (26°C)

Full comfort is provided with no cold feet.

Three Technologies That Achieved Circulation Airflow

- Use of new wide flaps (Straight)**
With new, larger flaps, a straighter trajectory for airflow was achieved.

Conventional flap^{*3} (3. FXFQ-S model) vs. New wide flap (Approx. doubled).
 New wide flap construction inhibits ceiling dirt and grime. By tapering both flap ends, the airflow that causes dirty ceilings is directed downward.
- Optimizing airflow angle (Horizontally)**
The airflow angle was made more horizontal.

Conventional flap^{*3} (3. FXFQ-S model) vs. New wide flap (20° horizontal flow).
 30° air direction: Cannot blow more than 30° horizontal. When set to 20° the airflow route gets narrow.
 20° air direction: A more horizontal 20° flow is realized. Even at 20°, the airflow route is sufficiently maintained.

- Increased velocity in 2-way flow (Strongly)**
Velocity increased by making 2-way flow. Powerful airflow was realized.

All-round flow vs. Two-way flow (Velocity 10% increase!).
 *4. Other 2 outlets are controlled by changing the flap direction (angle) to suppress airflow volume.

Things to remember when using circulation airflow

Main points for use

- Effectiveness may differ according to room conditions, room size, and distance to walls.
- Airflow operation differs when using the designer panel. (Operation repeatedly switches from 3-way horizontal flow to 4-way downward flow [swing] to 2-way horizontal flow to 4-way downward flow [swing].)
- Circulation airflow functions during connection with wired remote controller. (BRC1E63). However, use is not possible for the following conditions:
 - When a sealing material of air discharge outlet and branch ducts are used;
 - When individual airflow setting is selected;
 - When using group control other than round flow.

Installation conditions

Table 1) Distance to wall from indoor unit

Indoor unit capacity	FXF(S)Q 25-50	FXF(S)Q 63/80	FXF(S)Q 100-140
Distance range	1.5m-4m	1.5m-5m	1.5m-7m

Table 2) Minimum distance between indoor units

Indoor unit capacity	FXF(S)Q 25-50	FXF(S)Q 63/80	FXF(S)Q 100-140
Minimum distance	4m or more	5m or more	7m or more

Individual Airflow Direction Control^{*1}

^{*1} Applicable when wired remote controller BRC1E63 is used.

Comfortable air conditioning for all room layouts and conditions

Airflow direction can be individually adjusted for each air discharge outlet to deliver optimal air distribution.

Easy setting is possible with a wired remote controller.

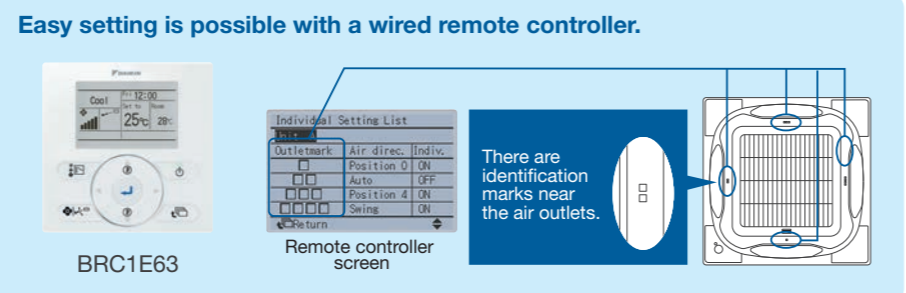

BRC1E63

Remote controller screen

There are identification marks near the air outlets.

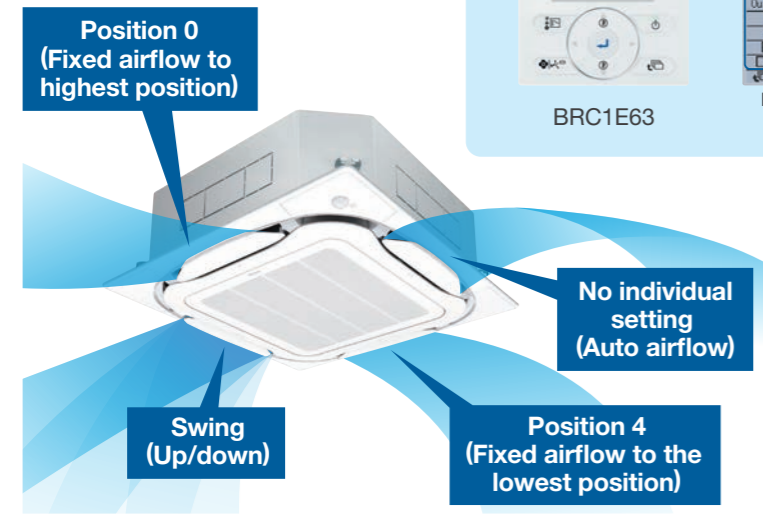

- Individual airflow settings**
- No individual setting (Auto airflow)
 - Position 0 (Highest point)
 - Position 1
 - Position 2
 - Position 3
 - Position 4 (Lowest point)
 - Swing
- Individual settings are possible as stated above.

When individual airflow is selected, airflow direction can be adjusted to room layout.

For offices

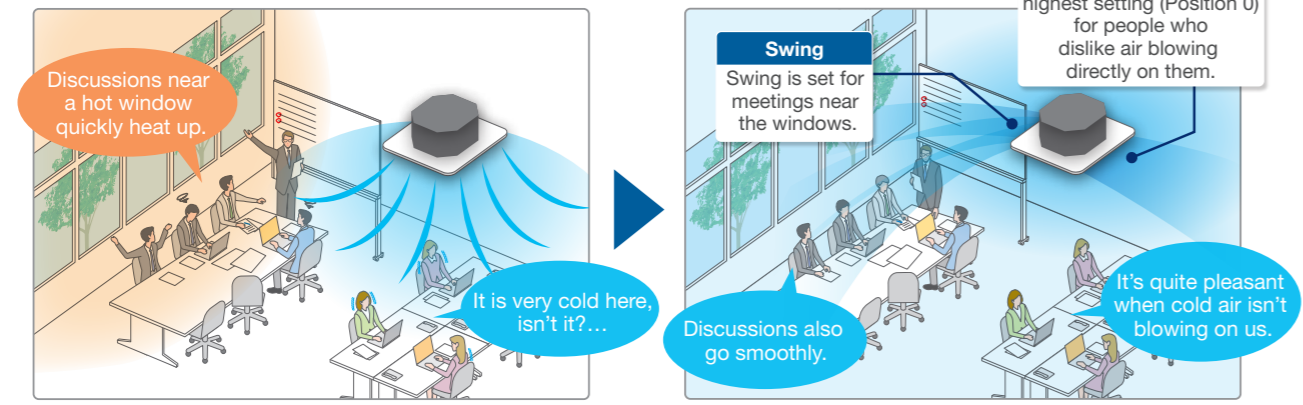

Discussions near a hot window quickly heat up.

It is very cold here, isn't it?...

Discussions also go smoothly.

Swing is set for meetings near the windows.

Position 0: The airflow is at the highest setting (Position 0) for people who dislike air blowing directly on them.

It's quite pleasant when cold air isn't blowing on us.

For shops and restaurant

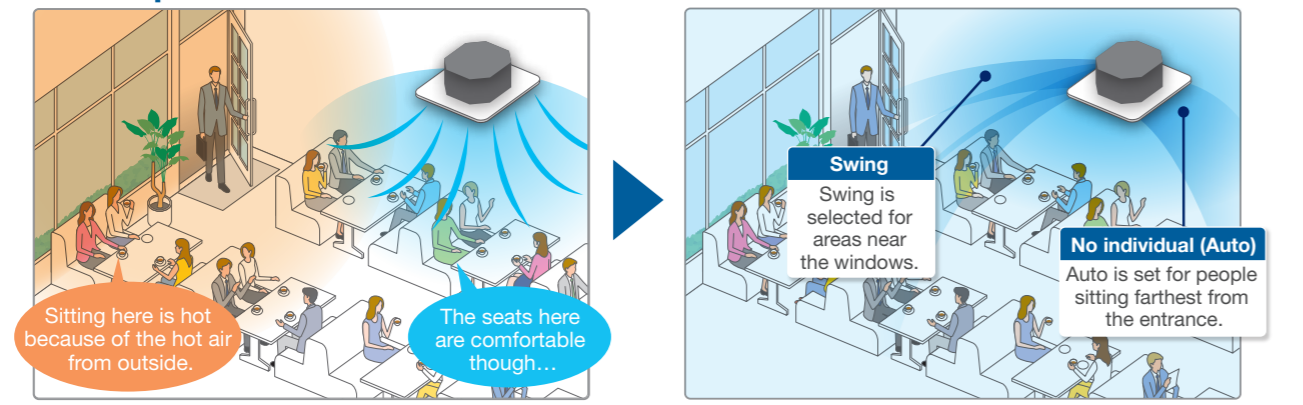

Sitting here is hot because of the hot air from outside.

The seats here are comfortable though...

Swing is selected for areas near the windows.

No individual (Auto): Auto is set for people sitting farthest from the entrance.

Ceiling Mounted Cassette (Round Flow with Sensing) Type **FXFSQ-A** Ceiling Mounted Cassette (Round Flow) Type **FXFQ-A**

Other Functions

Comfort

360° Airflow & Selectable Airflow Pattern

Indoor unit offers 360° airflow discharges air in all directions with more uniform temperature distribution. Because air flows out from corner outlets, comfort spreads more widely.

Typical flow patterns There are a total of 18 flow patterns.

All-round flow



(E.g., installed in middle of ceiling)
4-way flow also possible.

3-way flow



(E.g., installed near a wall)

L-shaped 2-way flow



(E.g., installed in a corner)

Opposite 2-way flow



(E.g., installed in a long room)

Required distance to wall surface for closing air discharge outlet

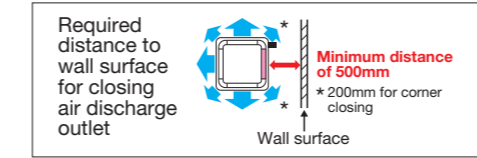

Wall surface

Note:

- Whatever the discharge direction, the same type of panel is used. If installing for other than all-round flow, an air discharge outlet sealing material (option) must be used to close each unused outlet.
- Operation sound increases when using 2-way or 3-way flow.
- Designer panel cannot operate 2-way and 3-way flow.

Optimal comfort and convenience assured by 3 air discharge modes

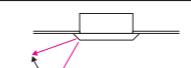
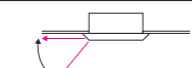
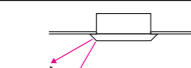
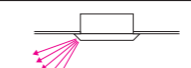
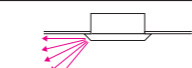
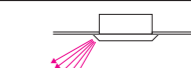
Air direction	Standard setting ¹	Draft prevention setting (field setting)	Ceiling soiling prevention setting ² (field setting)
Desired situation	For gentle drafts.	When drafts are unwanted.	For shops with light coloured ceilings that must be kept spotless.
Auto-swing			
5-level air direction setting			
Auto air direction control	The air direction is set automatically to the memorised position of the previous air direction.		

Note:

- ¹Air direction is set to the standard position when the unit is shipped from the factory. The position can be changed from the remote controller.
- ²Closing of the corner discharge outlets is recommended.

Switchable fan speed: 5 steps and Auto

Control of airflow rate has been improved from 3-step to 5-step. Auto airflow rate is newly available.

Suitable for high ceilings

Even in spaces with high ceilings, a comfortable airflow is carried down to the floor level.

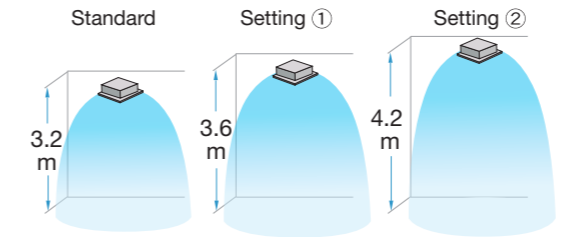

When all round flow is selected, ceilings up to 4.2 m in height can be accommodated. (FXF(S)Q100-140A)

Criteria for ceiling height and number of air discharge outlets (Ceiling height is reference value)

Ceiling height	Standard	Number of air discharge outlets used							
		FXF(S)Q25-80A				FXF(S)Q100-140A			
		All round flow	4-way flow	3-way flow	2-way flow	All round flow	4-way flow	3-way flow	2-way flow
Standard	2.7 m	3.1 m	3.0 m	3.5 m	3.2 m	3.4 m	3.6 m	4.2 m	
High ceiling ①	3.0 m	3.4 m	3.3 m	3.8 m	3.6 m	3.9 m	4.0 m	4.2 m	
High ceiling ②	3.5 m	4.0 m	3.5 m	—	4.2 m	4.5 m	4.2 m	—	

Note:

- The aforementioned is for standard panels. See the installation manual for designer panels.
- Factory settings are for standard ceiling height and all-round flow.
- High ceiling settings (1) and (2) are set with the remote controller by field setting.
- High-efficiency filters are not available for high ceiling applications.

Quick and Easy Installation

Lightweight

All models can be installed without using a lifter.

Installable in tight ceiling spaces

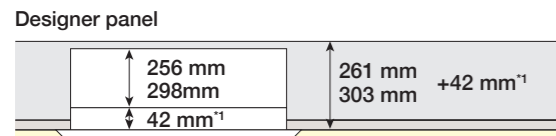
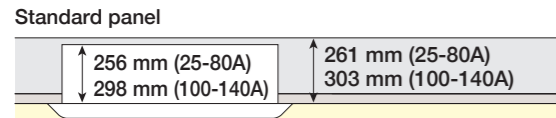

*1. Body height (ceiling required space) is 42 mm higher than standard panel.

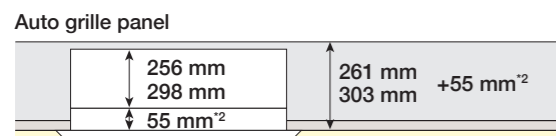

*2. Body height (ceiling required space) is 55 mm higher than standard panel.

*When the ceiling space is limited, an optional panel spacer is available. (See page 87)

Easy height adjustment

Each corner of the unit has an adjuster pocket that lets you easily adjust the unit's suspended height.

Note:
If the wireless remote controller is installed, a signal receiver unit is housed in one of the adjuster pockets.

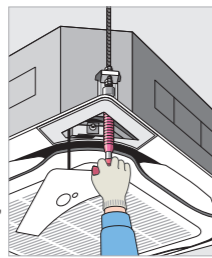

Temporary placement of control box lid

Because the control box lid can be temporarily hung on the unit, there is no need to climb down the stepladder to retrieve it.

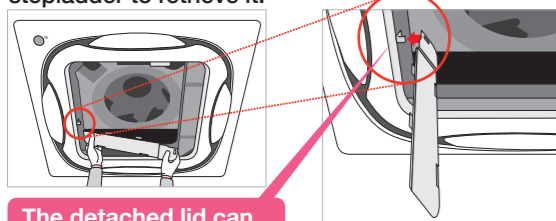

The detached lid can be hung on a hook.

Installed in any direction

Since the orientation of the suction grille can be adjusted after installing, the direction of the suction grille lines can be unified when multiple units are installed.

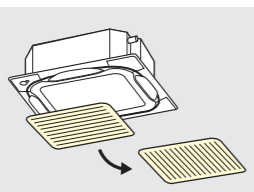

Easy hanging

Washer fixing plates secure washers in place and prevent washers from falling for easy installation.

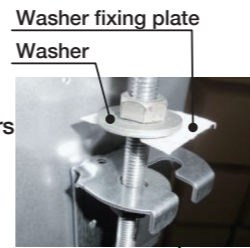

Easy removal of corner cover

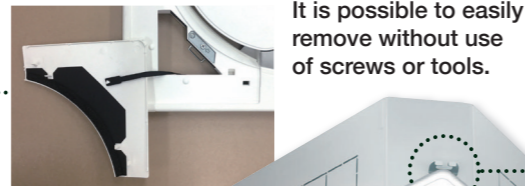

It is possible to easily remove without use of screws or tools.

Ease in temporary hanging of decoration panel

In addition to the temporary hanging fixtures in 2 places normally used, corner part mounting fixtures in 4 places are provided.

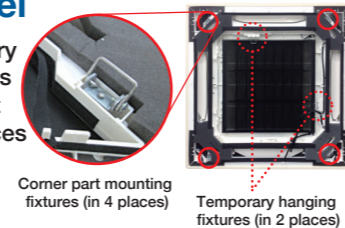

Drain pump

Equipped as standard accessory with 850 mm lift.

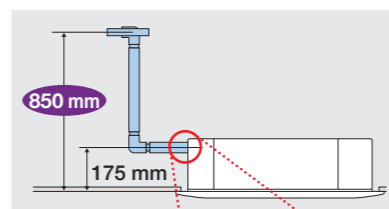

Transparent drain socket



Hanging height adjustment

Because the configuration of the hanger bracket changed, the dimensions from the ceiling to the hanger bracket also change during height adjustment for indoor unit.

	A Dimensions
Standard panel	125-130mm
Designer panel	167-172mm
Auto grille panel	180-185mm
Chamber option*+ standard panel	175-180mm

*High-efficiency filter, ultra long-life filter, and fresh air intake

Ceiling Mounted Cassette
(Round Flow with Sensing) Type

FXFSQ-A

Ceiling Mounted Cassette
(Round Flow) Type

FXFQ-A

Easy Maintenance

Drain pan and drain water check

The condition of the drain pan and drain water can be checked by removing the suction grille and drain plug.

Note: For inquiries concerning auto grille panel installations, please contact your local dealer or Daikin representative.

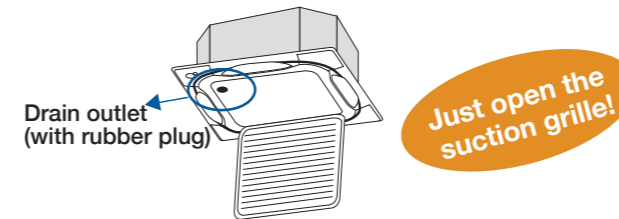

24 mm diameter drain outlet

The drain outlet allows insertion of a finger or dental mirror for inspection of the internal cleanliness of the drain pan. Removal of the suction panel enables access.

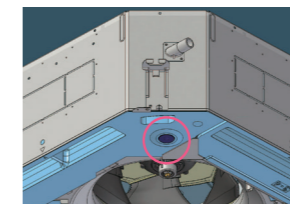

Auto grille panel (option)

Grille and air filter cleaning can be performed without need for a stepladder by lowering the grille.

A dedicated remote controller for the auto grille panel is included. Operation is not possible using BRC1E63.

The drop length corresponds to ceiling height and can be set for 8 different levels.

Ceiling Height Standard (m)	Drop Length
2.4	1.2
2.7	1.6
3.0	2.0
3.5	2.4
3.8	2.8
4.2	3.1
4.5	3.5
5.0*	3.9

*Airflow range is up to 4.5m. Please refer to "criteria for ceiling height and number of air discharge outlets" on page 32.



Ultra long-life filter (option)

See page 87

Maintenance is not required in normal shops or offices for up to four years.

Cleanliness

Silver ion anti-bacterial drain pan

A built-in antibacterial treatment that uses silver ion in the drain pan prevents the growth of slime, bacteria, and mould that cause odours and clogging.

(The lifespan of a silver ion cartridge depends on the usage environment, but should be changed once every two to three years.)



Non-flocking flaps

Flaps can be detached without use of tools. Condensation does not easily form and dirt does not cling to non-flocking flaps. They are easy to clean.



Filter has anti-mould and antibacterial treatment

Prevents mould and microorganisms growing out of the dust and moisture that adheres to the filters.

Ceiling Mounted Cassette (Compact Multi Flow) Type FXZQ-A

Quiet, compact, and designed for user comfort

Compact & elegant design

- Fully-flat integration in standard architectural ceiling tiles, leaving only 8 mm
- Remarkable blend of iconic design and engineering excellence with an elegant finish in white
- The newly designed panel integrates fully within one ceiling tile enabling lights, speakers and sprinklers to be installed in the adjoining ceiling tiles.

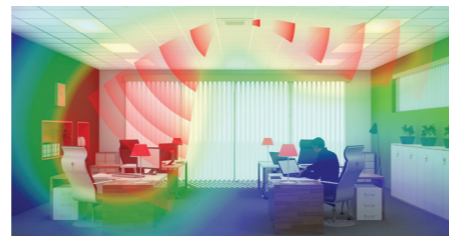
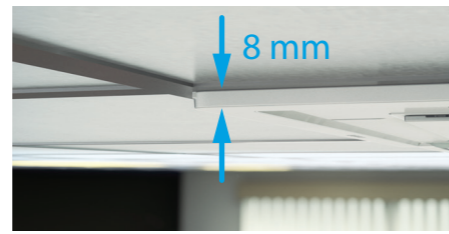
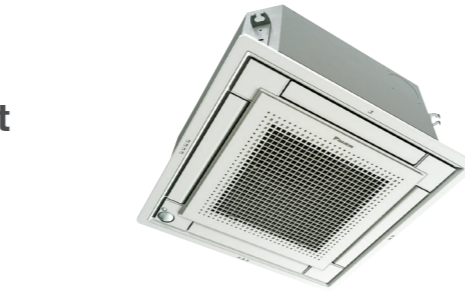

Efficiency & comfort

Dual sensors (Option)

- Two optional intelligent sensors improve energy efficiency and comfort.
- An optional presence and floor sensor kit can be fitted to the cassette for draught prevention, energy-saving operation and to provide optimal control of airflow.

Individual airflow direction control *1

- Airflow direction can be individually adjusted for each air discharge outlet to deliver optimal air distribution. *1. This function can only be set via wired remote controller BRC1E63.

Auto swing (up/down)

Possibility to select automatic vertical moving of the air discharge flaps for efficient air and temperature distribution throughout the room.

Cleanliness

Ceiling soiling prevention

Prevents air from blowing against the ceiling to prevent ceiling stains.

4-way Flow Ceiling Suspended Type FXUQ-A

Slim and stylish design, optimum air distribution, installation without ceiling cavity

- Unit body and suction panel adopted round shapes and realised a slim appearance design. The unit can be used for various locations such as the ceilings with no cavity and bare ceilings.
- Flaps close automatically when the unit stops, which gives a simple appearance.
- Unified slim height of 198 mm for all model that gives the unified impression even when models with different capacities are installed in the same area.
- With adoption of the individual flap control, airflow direction adjustment can be individually set for each air outlet. 5 directions of airflow and auto-swing can be selected with wired remote controller BRC1E63, which realises the optimum air distribution.

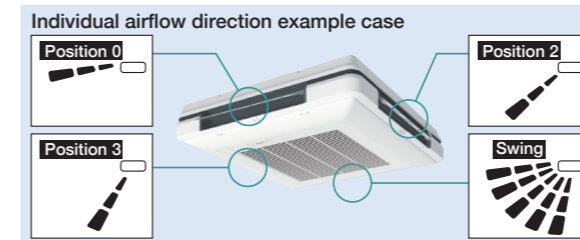

- Control of the airflow rate has been improved from 2-step to 3-step control. Auto airflow rate control can be selected with wired remote controller BRC1E63 and BRC2E61.



- Built-in electronic expansion valve eliminates the need for a BEV unit, which improves flexibility of installation.

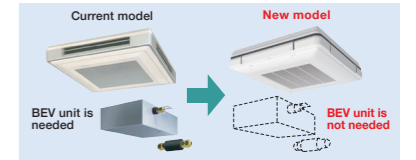

- Energy efficiency has been improved thanks to the adoption of a new heat exchanger with smaller tubes, DC fan motor and DC drain pump motor.
- Drain pump is equipped as a standard accessory, and the lift height has been improved from 500 mm to 600 mm.
- Depending on installation site requirements or room conditions, 2-way, 3-way and 4-way discharge patterns are available.



- An antibacterial treatment that uses silver ions has been applied to the drain pan, preventing the growth of slime, mould and bacteria that cause blockages and odours. (The lifespan of a silver ion cartridge depends on the usage environment, but should be changed once every two to three years.)



Specifications

MODEL		FXUQ71AVEB	FXUQ100AVEB
Power supply		1-phase, 220-240 V/220-230 V, 50/60 Hz	
Cooling capacity	Btu/h	27,300	38,200
	kW	8.0	11.2
Power consumption	kW	0.090	0.200
Casing		Fresh white	
Airflow rate (H/M/L)	m ³ /min	22.5/19.5/16	31/26/21
	cfm	794/688/565	1,094/918/741
Sound level (H/M/L)	dB(A)	40/38/36	47/44/40
Dimensions (HxWxD)	mm	198x950x950	
Machine weight	kg	26	27
Piping connections	Liquid (Flare)	φ9.5	
	Gas (Flare)	φ15.9	
	Drain	VP20 (External Dia. 26/Internal Dia. 20)	

Note: Specifications are based on the following conditions;

- Cooling: Indoor temp.: 27°CDB, 19°CWB, Outdoor temp.: 35°CDB, Equivalent piping length: 7.5 m, Level difference: 0 m.
- Capacity of indoor unit is only for reference. Actual capacity of indoor unit is based on the total capacity index. (See Engineering Data Book for details.)
- Sound level: Anechoic chamber conversion value, measured at a point 1 m in front of the unit and 1 m downward. During actual operation, these values are normally somewhat higher as a result of ambient conditions

Ceiling Mounted Cassette (Double Flow) Type

FXCQ-A

Sophisticated panel design blends easily with any interior



New panel design

- This model features a stylish flat panel with fresh white colour for a new sophisticated appearance.
- The flat flaps close entirely when the unit is not operating and there are no air intake grilles visible.

Individual Airflow Direction Control^{*1}

- Airflow direction can be individually adjusted for each air discharge outlet to deliver optimal air distribution.

^{*1}. Applicable when wired remote controller BRC1E63 is used.

Easy setting is possible with a wired remote controller.

Outletmark	Air direc.	Indiv.
□	Swing	ON
□	Position 0	ON
□	-	-
Return	-	-

There are identification marks near the air outlets.

Individual airflow settings

- No individual setting (Auto airflow)
- Position 0 (Highest point)
- Position 1
- Position 2
- Position 3
- Position 4 (Lowest point)
- Swing

Individual settings are possible as stated above.

Switchable fan speed: 5 steps and Auto

- Control of airflow rate has been improved from 3-step to 5-step. Auto airflow rate is newly available.

Suitable for high ceilings

- Even in spaces with high ceilings maximum 3.5 m, a comfortable airflow is carried down to the floor level.

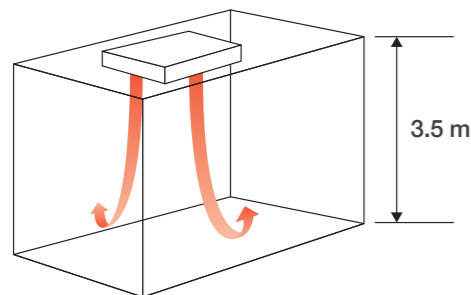

Energy saving : Reduction of energy consumption

- Power consumption is significantly reduced by specially developed small tube heat exchanger and DC fan motor.

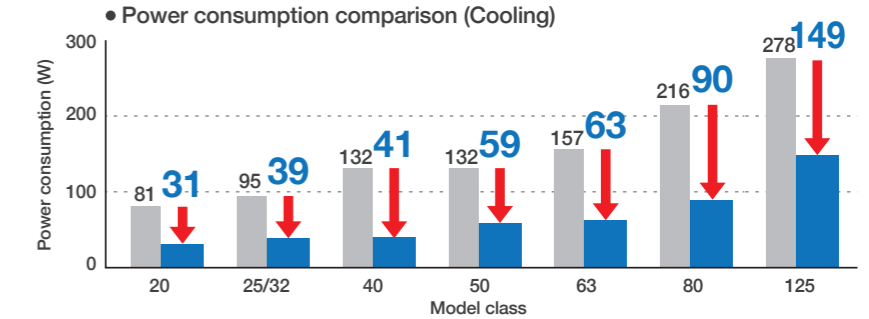

Enhanced functions from various aspects such as maintenance

- The flap parts are easy to clean because it is hard to condensate and get dirty.
- Check contamination in drain pan by simply remove suction grille and panel.
- Equipped with long life filter which requires only 1-year maintenance interval.

- Drain pump is equipped as standard accessory with 850 mm lift.

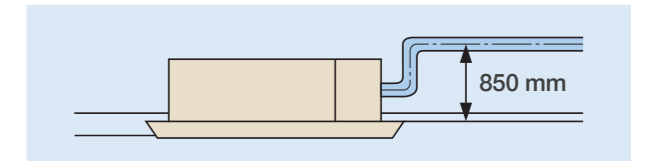

- Adjuster pockets mount at four corners of the unit enable to adjust the main unit without removing the panel.

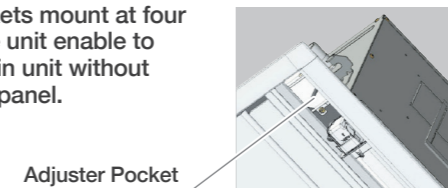

- Easy visual inspection of drainage through the transparent body drain socket.



- An antibacterial treatment that uses silver ions has been applied to the drain pan, preventing the growth of slime, mould and bacteria that cause blockages and odours. (The lifespan of a silver ion cartridge depends on the usage environment, but should be changed once every two to three years.)



Specifications

MODEL		FXCQ20AVM	FXCQ25AVM	FXCQ32AVM	FXCQ40AVM	FXCQ50AVM	FXCQ63AVM	FXCQ80AVM	FXCQ125AVM
Power supply		1-phase, 220-240 V/220-230 V, 50/60 Hz							
Cooling capacity	Btu/h	7,500	9,600	12,300	15,400	19,100	24,200	30,700	47,800
	kW	2.2	2.8	3.6	4.5	5.6	7.1	9.0	14.0
Power consumption		0.031	0.039	0.041	0.059	0.063	0.090	0.149	
Casing		Galvanised steel plate							
Airflow rate (H/HM/M/ML/L)	m ³ /min	10.5/9.5/9/8/7.5	11.5/10.5/9.5/8.5/8	12/11/10.5/9.5/8.5	15/14/13/11.5/10.5	16/15/14/12.5/11.5	26/24/22.5/20.5/18.5	32/29.5/27.5/25/22.5	
	cfm	371/335/318/282/265	406/371/335/300/282	424/388/371/335/300	530/494/459/406/371	565/530/494/441/406	918/847/794/724/653	1,130/1,041/971/883/794	
Sound level (H/HM/M/ML/L)		32/31/30/29/28	34/33/31/30/29	34/33/32/31/30	36/35/33/32/31	37/36/35/33/31	39/38/37/35/32	42/40/38/36/33	46/44/42/40/38
Dimensions (HxWxD)		305x775x620			305x990x620		305x1,445x620		
Machine weight		19			22		25		33
Piping connections	Liquid (Flare)	φ 6.4			φ 9.5				
	Gas (Flare)	φ 12.7			φ 15.9				
	Drain	VP25 (External Dia. 32/Internal Dia. 25)							
Panel (Option)	Model	BYBCQ40CF			BYBCQ63CF		BYBCQ125CF		
	Colour	Fresh white (6.5Y 9.5/0.5)							
	Dimensions (HxWxD)	55x1,070x700			55x1,285x700		55x1,740x700		
Weight		10			11		13		

Note: Specifications are based on the following conditions:

- Cooling: Indoor temp.: 27°CDB, 19°CWB, Outdoor temp.: 35°CDB, Equivalent piping length: 7.5 m, Level difference: 0 m.
- Capacity of indoor unit is only for reference. Actual capacity of indoor unit is based on the total capacity index. (See Engineering Data Book for details.)
- Sound level: Anechoic chamber conversion value, measured at a point 1.5 m downward from the unit centre. During actual operation, these values are normally somewhat higher as a result of ambient conditions.

Ceiling Mounted Cassette Corner Type

FXKQ-MA

Slim design for flexible installation

- Slim body needs only 220 mm space above the ceiling. If you use a panel spacer (option), the unit can be installed in the minimum space of 195 mm.

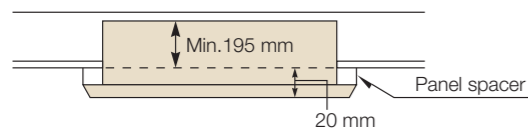

- Single-flow type allows effective air discharge from corner or from drop-ceiling.

- Drain pump is equipped as standard accessory with 500 mm lift.

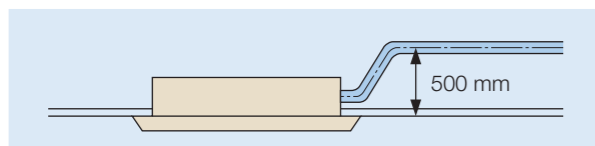

- Providing 3 different settings of standard, draft prevention and ceiling soiling prevention, the auto swing mechanism realises even distribution of airflow and room temperature.

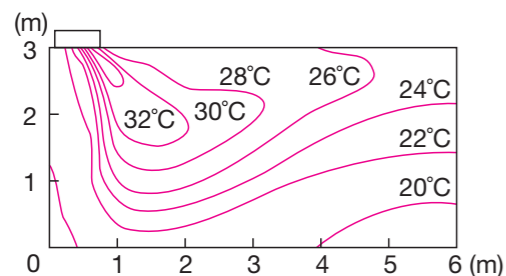

- Front discharge is possible with an air discharge unit (option), which allows the installation in the drop-ceiling or sagging wall.

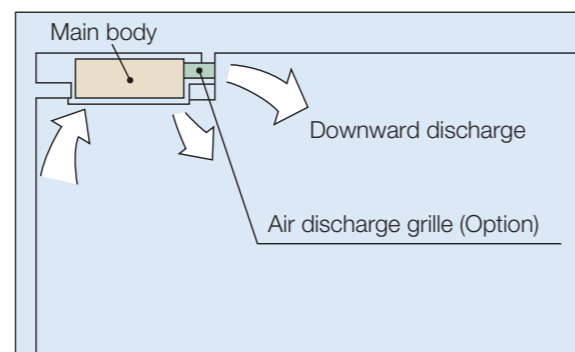

*Set for front discharge using a suspended ceiling.

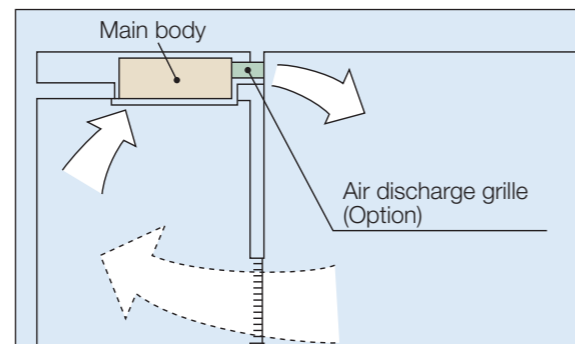

*Downward discharge is shut off and air is blown straight out (front discharge).

- A long-life filter (maintenance free up to one year*) is equipped as standard accessory.

* 8 hr/day, 25 day/month. For dust concentration of 0.15 mg/m³



Specifications

MODEL		FXKQ25MAVE	FXKQ32MAVE	FXKQ40MAVE	FXKQ63MAVE
Power supply		1-phase, 220 - 240 V/220 V, 50/60 Hz			
Cooling capacity	Btu/h	9,600	12,300	15,400	24,200
	kW	2.8	3.6	4.5	7.1
Power consumption	kW	0.066		0.076	0.105
Casing		Galvanised steel plate			
Airflow rate (H/L)	m ³ /min	11/9		13/10	18/15
	cfm	388/318		459/353	635/530
Sound level (H/L)	220 V	38/33		40/34	42/37
	240 V	40/35		42/36	44/39
Dimensions (HxWxD)	mm	215x1,110x710			215x1,310x710
Machine weight	kg	31			34
Piping connections	Liquid (Flare)	φ 6.4			φ 9.5
	Gas (Flare)	φ 12.7			φ 15.9
	Drain	VP25 (External Dia. 32/Internal Dia. 25)			
Panel (Option)	Model	BYK45FJW1			BYK71FJW1
	Colour	White (10Y9/0.5)			
	Dimensions(HxWxD)	70x1,240x800			70x1,440x800
	Weight	8.5			9.5

Note: Specifications are based on the following conditions;

- Cooling: Indoor temp.: 27°CDB, 19°CWB, Outdoor temp.: 35°CDB, Equivalent piping length: 7.5 m, Level difference: 0 m.
- Capacity of indoor unit is only for reference. Actual capacity of indoor unit is based on the total capacity index. (See Engineering Data Book for details.)
- Sound level: Anechoic chamber conversion value, measured at a point 1 m in front of the unit and 1 m downward. During actual operation, these values are normally somewhat higher as a result of ambient conditions.

Slim Ceiling Mounted Duct Type

FXDQ-PD / ND

Slim design, quietness and static pressure switching

Suitable to use in drop-ceilings!

- Only 700 mm in width and 23 kg in weight, this model is suitable to install in limited spaces like drop-ceilings in hotels.

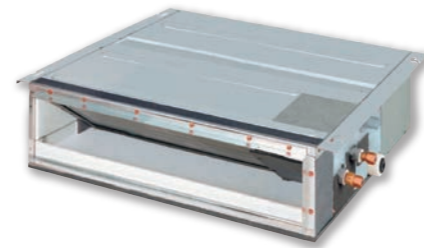
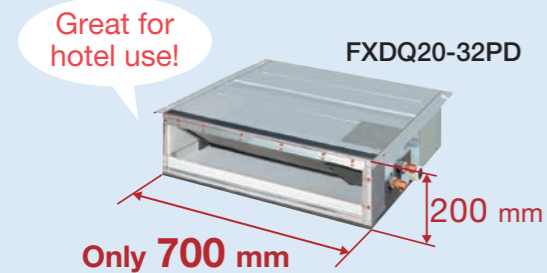

- Only 200 mm in height, this model can be installed in rooms with as little as 240 mm in height for the ceiling space between the drop-ceiling and ceiling slab.

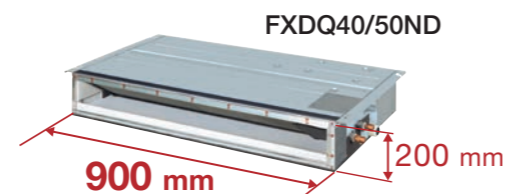

* 1,100 mm in width for the FXDQ63ND model.

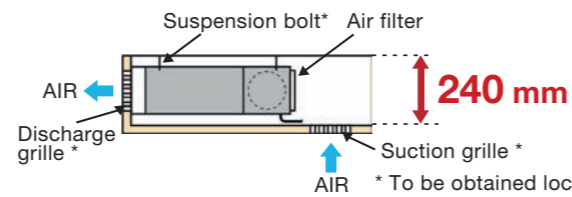

* To be obtained locally

- Control of the airflow rate can be selected from 3-step control and Auto. Auto airflow rate control can be selected with wired remote controller BRC1E63 and BRC2E61.

- Low operation sound level.

- External static pressure selectable by remote controller switching make this indoor unit a very comfortable and flexible model.
10 Pa-30 Pa/factory set: 10 Pa for FXDQ-PD models.
15 Pa-44 Pa/factory set: 15 Pa for FXDQ-ND models.

- FXDQ-PD and FXDQ-ND models are available in two types to suit different installation conditions.

FXDQ-PD/NDVE: with a drain pump (750 mm lift) as a standard accessory
FXDQ-PD/NDVET: without a drain pump

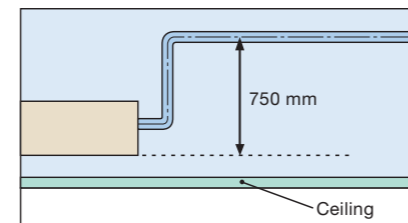

Specifications

MODEL	with drain pump	FXDQ20PDVE	FXDQ25PDVE	FXDQ32PDVE	FXDQ40NDVE	FXDQ50NDVE	FXDQ63NDVE	
	without drain pump	FXDQ20PDVET	FXDQ25PDVET	FXDQ32PDVET	FXDQ40NDVET	FXDQ50NDVET	FXDQ63NDVET	
Power supply	1-phase, 220-240 V/220 V, 50/60 Hz							
Cooling capacity	Btu/h	7,500	9,600	12,300	15,400	19,100	24,200	
	kW	2.2	2.8	3.6	4.5	5.6	7.1	
Power consumption (FXDQ-PD/NDVE) *1	kW	0.086		0.089	0.160	0.165	0.181	
Power consumption (FXDQ-PD/NDVET) *1	kW	0.067		0.070	0.147	0.152	0.168	
Casing	Galvanised steel plate							
Airflow rate (HH/H/L)	m ³ /min	8.0/7.2/6.4			10.5/9.5/8.5	12.5/11.0/10.0	16.5/14.5/13.0	
	cfm	282/254/226			371/335/300	441/388/353	583/512/459	
External static pressure	Pa	30-10*2			44-15*2			
Sound level (HH/H/L)*1*3	dB(A)	28/26/23		28/26/24	30/28/26	33/30/27	33/31/29	
Dimensions (H×W×D)	mm	200×700×620			200×900×620		200×1,100×620	
Machine weight	kg	23			27	28	31	
Piping connections	Liquid (Flare)	φ6.4					φ9.5	
	Gas (Flare)	φ12.7					φ15.9	
	Drain	VP20 (External Dia. 26/Internal Dia. 20)						

Note: Specifications are based on the following conditions;

•Cooling: Indoor temp.: 27°CDB, 19°CWB, Outdoor temp.: 35°CDB, Equivalent piping length: 7.5 m, Level difference: 0 m.

•Capacity of indoor unit is only for reference. Actual capacity of indoor unit is based on the total capacity index. (See Engineering Data Book for details.)

•Sound level: Anechoic chamber conversion value, measured at a point 1.5 m downward from the unit centre.

During actual operation, these values are normally somewhat higher as a result of ambient conditions.

*1 : Values are based on the following conditions: FXDQ-PD: external static pressure of 10 Pa; FXDQ-ND: external static pressure of 15 Pa.

*2 : External static pressure is changeable to set by the remote controller. This pressure means "High static pressure - Standard". (Factory setting is 10 Pa for FXDQ-PD models and 15 Pa for FXDQ-ND models.)

*3 : The values of operation sound level represent those for rear-suction operation. Sound level values for bottom-suction operation can be obtained by adding 5 dB(A).

Middle Static Pressure Ceiling Mounted Duct Type

FXSQ-PA

Middle static pressure and slim design allow flexible installations



Installation flexibility

Slim design

- With a height of only 245 mm, installation is possible even in buildings with narrow ceiling spaces.

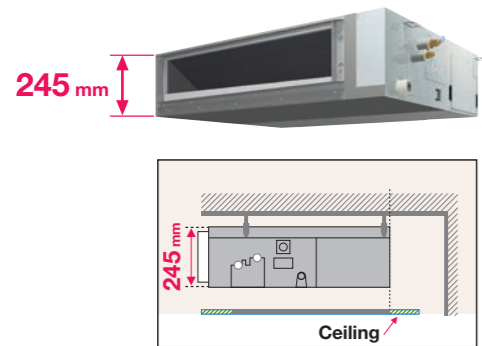

Standard DC drain pump

- DC drain pump is equipped as standard accessory with 850 mm lift.

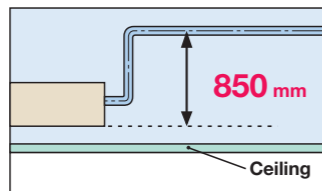

Bottom suction possible

- Bottom suction is possible which facilitate installation and maintenance. Wiring connections and maintenance of control box can be done from under the unit with an optional shield plate for side plate*, extending the degree of freedom for installation in the ceiling.

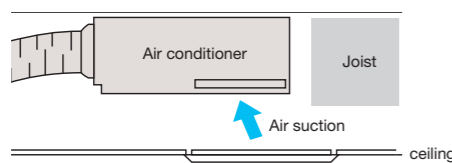

- Air suction direction can be altered from rear to bottom suction.

Rear suction

Bottom suction

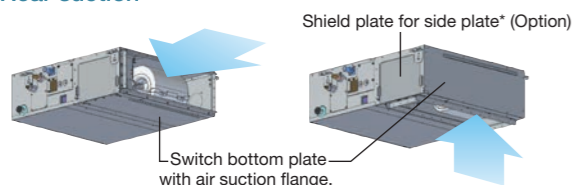

*An optional shield plate for side plate is required if wiring connections and maintenance of control box are needed from under the unit. This option is only available for FXSQ20-125PA models.

Design flexibility

Adjustable external static pressure

- Using a DC fan motor, the external static pressure can be controlled within a range of 30 Pa* to 150 Pa.

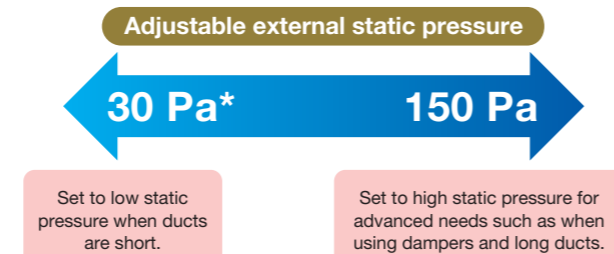

Comfortable airflow is achieved in accordance with conditions such as duct length.

- *30 Pa-150 Pa for FXSQ20-40PAVE
- 50 Pa-150 Pa for FXSQ50-125PAVE
- 50 Pa-140 Pa for FXSQ140PAVE

Comfort

Switchable airflow rate

- Control of the airflow rate can be selected from 3-step control.

Auto airflow rate

- 5-step airflow rate is automatically controlled in accordance with the difference between room temperature and set temperature. Auto airflow rate control can be selected with wired remote controller BRC1E63 and BRC2E61.

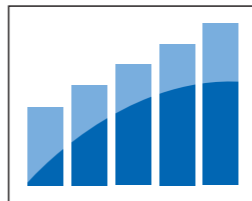

Low operation sound level

FXSQ-PAVE	20/25	32	40	50	63
Sound level (H/M/L)	33/30/28	34/32/30	36/33/30	34/32/29	36/32/29
FXSQ-PAVE	80	100	125	140	
Sound level (H/M/L)	37.5/34/30	39/35/32	42/38.5/35	43/40/36	

Easy maintenance

- Inspection and cleaning is facilitated by separating the drain pipe and inspection opening and by the drain pan maintenance check hole.

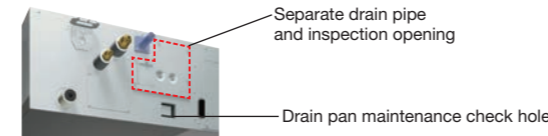

- An antibacterial treatment that uses silver ions has been applied to the drain pan, preventing the growth of slime, mould and bacteria that cause blockages and odours. (The lifespan of a silver ion cartridge depends on the usage environment, but should be changed once every two to three years.)

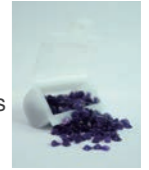

Easy installation

"Airflow rate auto adjustment function" at field setting (local setting by remote controller)

*This function can only be set via BRC1E63 and BRC2E61.

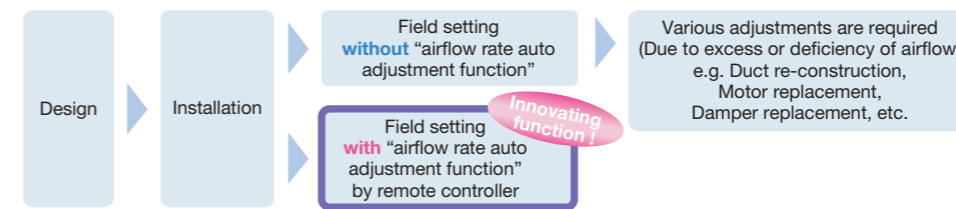

<Mechanism>

- During field setting, power input of DC fan is detected.
- External static pressure is estimated from power input of DC fan because PCB of FXSQ-PA has table of external static pressure vs. power input of DC fan.
- Actual duct resistance is calculated according to 1 and 2.
- Fan speed is automatically adjusted to produce rated airflow.

Note: * "Airflow rate auto adjustment function" can be adjusted within ±10% of rated airflow. (Refer to Engineering Data Book for details)
 * "Airflow rate auto adjustment function" should be used at field setting only.

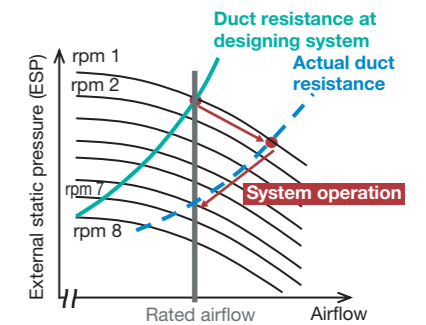

Specifications

MODEL	FXSQ20PAVE	FXSQ25PAVE	FXSQ32PAVE	FXSQ40PAVE	FXSQ50PAVE	
Power supply	1-phase, 220-240 V/220 V, 50/60 Hz					
Cooling capacity	Btu/h	7,500	9,600	12,300	15,400	19,100
	kW	2.2	2.8	3.6	4.5	5.6
Power consumption	kW	0.058 *1		0.066 *1	0.101 *1	0.075 *1
Casing	Galvanised steel plate					
Airflow rate (H/M/L)	m ³ /min	9/7.5/6.5	9.5/8/7	15/12.5/10.5	17/14.5/11.5	
	cfm	318/265/230	335/282/247	530/441/371	600/512/406	
External static pressure	Pa	30-150 (50) *2			50-150 (50) *2	
Sound level (H/M/L)	dB(A)	33/30/28	34/32/30	36/33/30	34/32/29	
Dimensions (H×W×D)	mm	245×550×800		245×700×800	245×1,000×800	
Machine weight	kg	25		27	35	
Piping connections	Liquid (Flare)	φ 6.4				
	Gas (Flare)	φ 12.7				
	Drain	VP25 (External Dia. 32/Internal Dia. 25)				

MODEL	FXSQ63PAVE	FXSQ80PAVE	FXSQ100PAVE	FXSQ125PAVE	FXSQ140PAVE	
Power supply	1-phase, 220-240 V/220 V, 50/60 Hz					
Cooling capacity	Btu/h	24,200	30,700	38,200	47,800	54,600
	kW	7.1	9.0	11.2	14.0	16.0
Power consumption	kW	0.106 *1	0.126 *1	0.151 *1	0.206 *1	0.222 *1
Casing	Galvanised steel plate					
Airflow rate (H/M/L)	m ³ /min	21/17.5/14.5	23/19.5/16	32/27/22.5	37/31.5/26	39/33.5/28
	cfm	741/618/512	812/688/565	1,130/953/794	1,306/1,112/918	1,377/1,183/988
External static pressure	Pa	50-150 (50) *2				50-140 (50) *2
Sound level (H/M/L)	dB(A)	36/32/29	37.5/34/30	39/35/32	42/38.5/35	43/40/36
Dimensions (H×W×D)	mm	245×1,000×800		245×1,400×800	245×1,550×800	
Machine weight	kg	35	37	46	47	52
Piping connections	Liquid (Flare)	φ 9.5				
	Gas (Flare)	φ 15.9				
	Drain	VP25 (External Dia. 32/Internal Dia. 25)				

Note: Specifications are based on the following conditions:
 •Cooling: Indoor temp.: 27°CDB, 19°CWB, Outdoor temp.: 35°CDB, Equivalent piping length: 7.5 m, Level difference: 0 m.
 •Capacity of indoor unit is only for reference. Actual capacity of indoor unit is based on the total capacity index. (See Engineering Data Book for details.)
 •Sound level: Anechoic chamber conversion value, measured at a point 1.5 m downward from the unit centre. During actual operation, these values are normally somewhat higher as a result of ambient conditions.
 *1: Power consumption values are based on conditions of rated external static pressure.
 *2: External static pressure can be modified using a remote controller that offers thirteen (FXSQ20-40PA), eleven (FXSQ50-125PA) or ten (FXSQ140PA) levels of control. These values indicate the lowest and highest possible static pressures. The rated static pressure is 50 Pa.

Ceiling Mounted Duct Type

FXMQ-PA / M

Middle and high static pressure allows for flexible duct design

- Using a DC fan motor, the external static pressure can be controlled within a range of 30 Pa* to 200 Pa*.

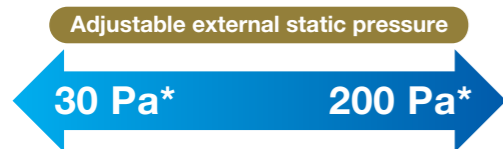

Set to low static pressure when ducts are short.

Set to high static pressure for advanced needs such as when using dampers and long ducts.

Comfortable airflow is achieved in accordance with conditions such as duct length.

- *30 Pa-100 Pa for FXMQ20PA-32PA
- *30 Pa-160 Pa for FXMQ40PA
- *50 Pa-200 Pa for FXMQ50PA-125PA
- *50 Pa-140 Pa for FXMQ140PA

- All models are only 300 mm in height and the weight of the FXMQ40-140PA has been reduced.
- Drain pump is equipped as standard accessory with 700 mm lift.

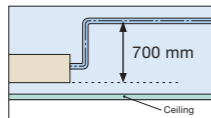

- Control of the airflow rate can be selected from 3-step control and Auto. Auto airflow rate control can be selected with wired remote controller BRC1E63 and BRC2E61.
- Low operation sound level
- Energy-efficient
 - DC fan motor is used to realise energy-saving operation.

- Easy maintenance
 - Inspection and cleaning is facilitated by separating the drain pipe and inspection opening and by the drain pan maintenance check hole.

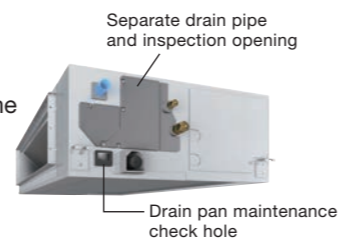

- An antibacterial treatment that uses silver ions has been applied to the drain pan, preventing the growth of slime, mould and bacteria that cause blockages and odours. (The lifespan of a silver ion cartridge depends on the usage environment, but should be changed once every two to three years.)



Easy installation

"Airflow rate auto adjustment function" at field setting (local setting by remote controller)

*This function is not available with FXMQ140PAVE.

*This function can only be set via BRC1E63 and BRC2E61.

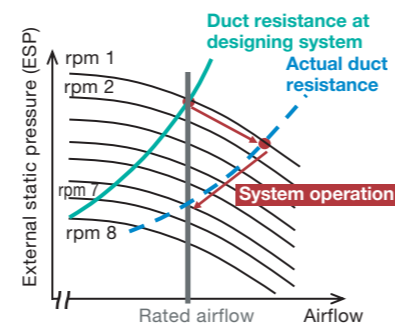
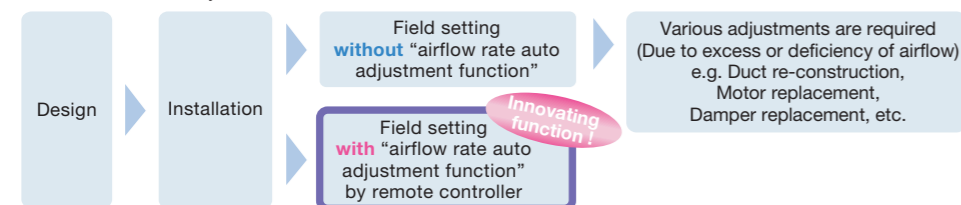

<Mechanism>

- During field setting, power input of DC fan is detected.
- External static pressure is estimated from power input of DC fan because PCB of FXMQ-PA has table of external static pressure vs. power input of DC fan.
- Actual duct resistance is calculated according to 1 and 2.
- Fan speed is automatically adjusted to produce rated airflow.

Note: * "Airflow rate auto adjustment function" can be adjusted within ±10% of rated airflow. (Refer to Engineering Data Book for details)
 * "Airflow rate auto adjustment function" should be used at field setting only.

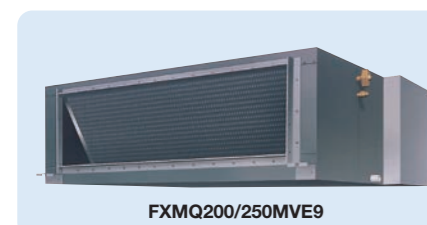

- Simplified Static Pressure Control**
External static pressure can be easily adjusted using a change-over switch inside the electrical box to meet the resistance in the duct system.
- Built-in Drain Pump (Option)**
Housing the drain pump inside the unit reduces the space required for installation.

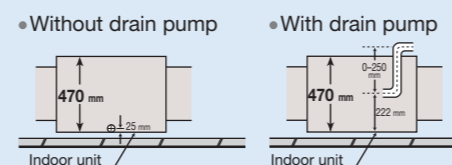

Specifications

MODEL	FXMQ20PAVE	FXMQ25PAVE	FXMQ32PAVE	FXMQ40PAVE	FXMQ50PAVE
Power supply	1-phase, 220-240 V/220 V, 50/60 Hz				
Cooling capacity	Btu/h	7,500	9,600	12,300	15,400
	kW	2.2	2.8	3.6	4.5
Power consumption	0.056 *1		0.060 *1		0.128 *1
Casing	Galvanised steel plate				
Airflow rate (HH/H/L)	m ³ /min	9/7.5/6.5		9.5/8/7	16/13/11
	cfm	318/265/230		335/282/247	565/459/388
External static pressure	30-100 (50) *2			30-160 (100) *2	50-200 (100) *2
Sound level (HH/H/L)	33/31/29		34/32/30		39/37/35
Dimensions (H×W×D)	300×550×700			300×700×700	300×1,000×700
Machine weight	25			27	35
Piping connections	Liquid (Flare)	φ 6.4			
	Gas (Flare)	φ 12.7			
	Drain	VP25 (External Dia. 32/Internal Dia. 25)			

MODEL	FXMQ63PAVE	FXMQ80PAVE	FXMQ100PAVE	FXMQ125PAVE	FXMQ140PAVE
Power supply	1-phase, 220-240 V/220 V, 50/60 Hz				
Cooling capacity	Btu/h	24,200	30,700	38,200	47,800
	kW	7.1	9.0	11.2	14.0
Power consumption	0.138 *1		0.185 *1		0.405 *1
Casing	Galvanised steel plate				
Airflow rate (HH/H/L)	m ³ /min	19.5/17.5/16	25/22.5/20	32/27/23	39/33/28
	cfm	688/618/565	883/794/706	1,130/953/812	1,377/1,165/988
External static pressure	50-200 (100) *2				50-140 (100) *2
Sound level (HH/H/L)	42/40/38		43/41/39		44/42/40
Dimensions (H×W×D)	300×1,000×700			300×1,400×700	
Machine weight	35		45		46
Piping connections	Liquid (Flare)	φ 9.5			
	Gas (Flare)	φ 15.9			
	Drain	VP25 (External Dia. 32/Internal Dia. 25)			

Note: Specifications are based on the following conditions:

- Cooling: Indoor temp.: 27°CDB, 19°CWB, Outdoor temp.: 35°CDB, Equivalent piping length: 7.5 m, Level difference: 0 m.
- Capacity of indoor unit is only for reference. Actual capacity of indoor unit is based on the total capacity index. (See Engineering Data Book for details.)
- Sound level: Anechoic chamber conversion value, measured at a point 1.5 m downward from the unit centre.

During actual operation, these values are normally somewhat higher as a result of ambient conditions.

*1: Power consumption values are based on conditions of rated external static pressure.

*2: External static pressure can be modified using a remote controller that offers seven (FXMQ20-32PA), thirteen (FXMQ40PA), fourteen (FXMQ50-125PA) or ten (FXMQ140PA) levels of control. These values indicate the lowest and highest possible static pressures. The rated static pressure is 50 Pa for FXMQ20-32PA and 100 Pa for FXMQ40-140PA.

MODEL	FXMQ200MVE9	FXMQ250MVE9	
Power supply	1-phase, 220-240 V/220 V, 50/60 Hz		
Cooling capacity	Btu/h	76,400	
	kW	22.4	
Power consumption	1.294 *1		
Casing	Galvanised steel plate		
Airflow rate (H/L)	m ³ /min	58/50	
	cfm	2,047/1,765	
External static pressure	132-221 *2		
Sound level (H/L)	220 V	48/45	
	240 V	49/46	
Dimensions (H×W×D)	470×1,380×1,100		
Machine weight	137		
Piping connections	Liquid (Flare)	φ 9.5	
	Gas (Brazing)	φ 19.1	
	Drain	PS1B	

Note: Specifications are based on the following conditions:

- Cooling: Indoor temp.: 27°CDB, 19°CWB, Outdoor temp.: 35°CDB, Equivalent piping length: 7.5 m, Level difference: 0 m.
- Capacity of indoor unit is only for reference. Actual capacity of indoor unit is based on the total capacity index. (See Engineering Data Book for details.)
- Sound level: Anechoic chamber conversion value, measured at a point 1.5 m downward from the unit centre.

During actual operation, these values are normally somewhat higher as a result of ambient conditions.

*1: Power consumption values are based on conditions of standard external static pressure.

*2: External static pressure is changeable to change over the connectors inside electrical box, this pressure means "Standard-High static pressure".

Ceiling Suspended Type

FXHQ-MA / A

Slim body with quiet and wide airflow

FXHQ32 / 63 / 100MA

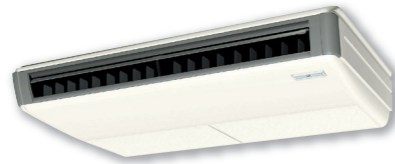

FXHQ125 / 140A



New 125 / 140 models provide greater capacity for large spaces

- The technology of the DC fan motor, wide sirocco fan, and large heat exchanger combine for greater airflow and quiet operation.

- Sophisticated design
 - Flap neatly closes when not in use.



- Suitable for high ceilings

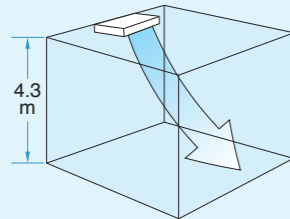

- Switchable fan speed: 3 steps

- Control of airflow rate has been improved from 2-step to 3-step.

- Drain pump kit (option) includes a silver ion antibacterial agent that assists in preventing the growth of slime, bacteria, and mould that cause smells and clogging.

- Wireless LCD remote controller

- A signal receiver must be added to the indoor unit.



BRC7M56



Signal receiver unit (Installed type)
Wireless remote controller is supplied in a set with a signal receiver.



Comfort

- Auto swing (up and down) and louvers (left and right by hand) bring comfort to the room.

- Louver manually adjusts for straight or wide angle airflow.

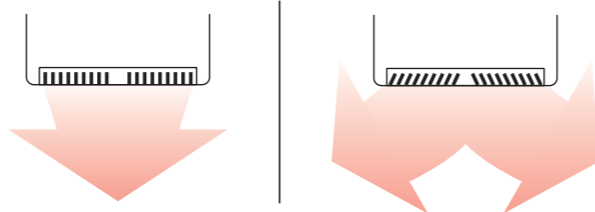

Quiet operation

- Uses quiet stream fan and other quiet technologies. (FXHQ32-100MA)

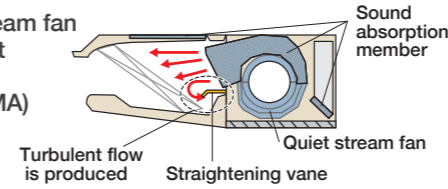

Indoor unit	Sound level		
	H	M	L
FXHQ32MA	36	—	31
FXHQ63MA	39	—	34
FXHQ100MA	45	—	37
FXHQ125A	46	41	37
FXHQ140A	48	42	37

Easy maintenance

- Non-dew flap
 - Condensation does not easily form on and dirt does not cling to non-dew flap. It is easy to clean.

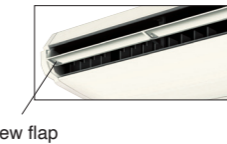

- Easy-clean, flat surfaces

- It is easy to wipe dirt off the flat side and lower surfaces of the unit.

- Oil-resistant plastic is used for the air suction grille. This satisfies durability in restaurants and other similar environments.

Note: Intended for use in salons, dining rooms, and ordinary sales floors, this specification is not suitable for kitchens or other harsh environments.

Specifications

MODEL	FXHQ32MAVE	FXHQ63MAVE	FXHQ100MAVE	FXHQ125AVM	FXHQ140AVM
Power supply	1-phase, 220-240 V/220 V, 50/60 Hz			1-phase, 220-240 V/220-230 V, 50/60 Hz	
Cooling capacity	Btu/h	12,300	24,200	38,200	48,000
	kW	3.6	7.1	11.2	14.1
Power consumption	kW	0.111	0.115	0.135	0.168
Casing	Sheet Metal / White (10Y9/0.5)			Sheet Metal / White	
Airflow rate (H/M/L)	m ³ /min	12/-/10	17.5/-/14	25/-/19.5	34/26/20
	cfm	424/-/353	618/-/494	883/-/688	1,200/918/706
Sound level (H/M/L)	dB(A)	36/-/31	39/-/34	45/-/37	46/41/37
Dimensions (H×W×D)	mm	195×960×680	195×1,160×680	195×1,400×680	235×1,590×690
Machine weight	kg	24	28	33	41
Piping connections	Liquid (Flare)	φ6.4	φ9.5		
	Gas (Flange)	φ12.7	φ15.9		
	Drain	VP20 (External Dia. 26/Internal Dia. 20)			

Note: Specifications are based on the following conditions;

- Cooling: Indoor temp.: 27°CDB, 19°CWB, Outdoor temp.: 35°CDB, Equivalent piping length: 7.5 m, Level difference: 0 m.
- Capacity of indoor unit is only for reference. Actual capacity of indoor unit is based on the total capacity index. (See Engineering Data Book for details.)
- Sound level: Anechoic chamber conversion value, measured at a point 1 m in front of the unit and 1 m downward. During actual operation, these values are normally somewhat higher as a result of ambient conditions.

Installation flexibility

- Flexible installation

- The unit fits more snugly into tight spaces. [Required installation space (mm)]

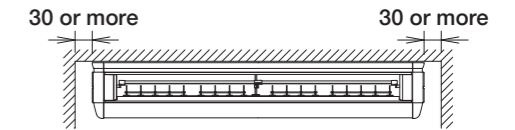

*Water used in the test-run can be drained from the air discharge opening rather than from the side as was formerly the case.

- Drain pump kit (option) can be easily incorporated.

- Drain pipe connection can be done inside the unit. Refrigerant and drain pipe outlets are at the same opening.

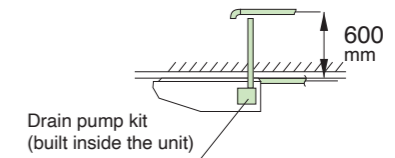

- All wiring and internal servicing can be done from under the unit.

- The rear side removable frame allows ease of access for piping work.

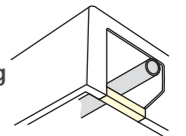

Wall Mounted Type

FXAQ-A

Stylish flat panel design harmonised with your interior décor



Higher airflow

- An invisible air intake at the top of the unit
- Vertical auto-swing enables efficient air and temperature distribution throughout the room.
- The louver closes automatically when the unit stops.
- Enhanced comfort is achieved.
- 5 step discharge angles can be set by remote controller.
- Discharge angle is automatically set at the same angle as previous operation when restart.



MODEL			FXAQ20A	FXAQ25A	FXAQ32A	FXAQ40A	FXAQ50A	FXAQ63A
Airflow rate	H	m³/min	9.1	9.4	9.8	12.2	15.0	19.0
	L		7.0	7.0	7.0	9.7	12.0	14.0

Lower sound level

- Whisper quiet in operation, with sound levels as low as 28.5 dB(A)*
*Sound level for FXAQ20-32A
- An ideal solution for a wide range of commercial spaces, including individual office spaces.



Wireless LCD remote controller

- A signal receiver must be added to the indoor unit.



MODEL			FXAQ20A	FXAQ25A	FXAQ32A	FXAQ40A	FXAQ50A	FXAQ63A
Sound level	H	dB(A)	33.0	35.0	37.5	37.0	41.0	46.5
	L		28.5	28.5	28.5	33.5	35.5	38.5

- Stylish flat panel design creates a graceful harmony that enhances any interior space.
- Flat panel can be cleaned with only the single pass of a cloth across their smooth surface. Flat panel can also be easily removed and washed for more thorough cleaning.
- Drain pan and air filter can be kept clean by mould-proof polystyrene.
- Flexible installation
 - Drain pipe can be fitted to from either left or right sides.
- Drain pump kit is available as optional accessory, which lifts the drain 1,000 mm from the bottom of the unit.

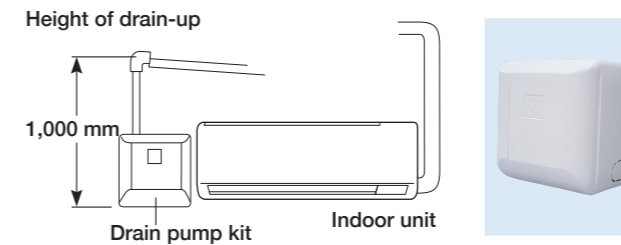

Specifications

MODEL		FXAQ20AVM	FXAQ25AVM	FXAQ32AVM	FXAQ40AVM	FXAQ50AVM	FXAQ63AVM
Power supply		1-phase, 220-240 V/220-230 V, 50/60 Hz					
Cooling capacity	Btu/h	7,500	9,600	12,300	15,400	19,100	24,200
	kW	2.2	2.8	3.6	4.5	5.6	7.1
Power consumption	kW	0.040	0.040	0.040	0.050	0.060	0.100
Casing		Resin / White N9.5					
Airflow rate (H/L)	m³/min	9.1/7.0	9.4/7.0	9.8/7.0	12.2/9.7	15.0/12.0	19.0/14.0
	cfm	321/247	332/247	346/247	431/342	530/424	671/494
Sound level (H/L)	dB(A)	33.0/28.5	35.0/28.5	37.5/28.5	37.0/33.5	41.0/35.5	46.5/38.5
Dimensions (HxWxD)	mm	290x795x266			290x1,050x269		
Machine weight	kg	12			15		
Piping connections	Liquid (Flare)	φ 6.4					φ 9.5
	Gas (Flange)	φ 12.7					φ 15.9
	Drain	VP13 (External Dia. 18/Internal Dia. 15)					

Note: Specifications are based on the following conditions;
 •Cooling: Indoor temp.: 27°CDB, 19°CWB, Outdoor temp.: 35°CDB, Equivalent piping length: 7.5 m, Level difference: 0 m.
 •Capacity of indoor unit is only for reference. Actual capacity of indoor unit is based on the total capacity index. (See Engineering Data Book for details.)
 •Sound level: Anechoic chamber conversion value, measured at a point 1 m in front of the unit and 1 m downward.
 During actual operation, these values are normally somewhat higher as a result of ambient conditions.

Floor Standing Type

FXLQ-MA

Suitable for perimeter zone air conditioning



- Floor Standing types can be hung on the wall for easier cleaning. Running the piping from the back allows the unit to be hung on walls. Cleaning under the unit, where dust tends to accumulate, is considerably easier.
- The adoption of a fibre-less discharge grille featuring an original design to prevent condensation also helps prevent staining and makes cleaning easier.
- A long-life filter (maintenance free up to one year*) is equipped as standard accessory.

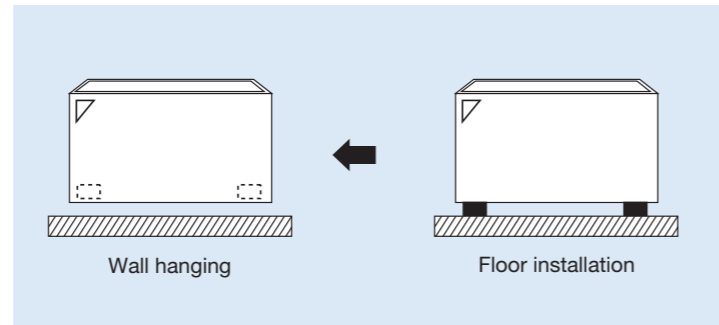

Specifications

MODEL		FXLQ20MAVE	FXLQ25MAVE	FXLQ32MAVE	FXLQ40MAVE	FXLQ50MAVE	FXLQ63MAVE
Power supply		1-phase, 220-240 V/220 V, 50/60 Hz					
Cooling capacity	Btu/h	7,500	9,600	12,300	15,400	19,100	24,200
	kW	2.2	2.8	3.6	4.5	5.6	7.1
Power consumption	kW	0.049		0.090		0.110	
Casing		Ivory white (5Y7.5/1)					
Airflow rate (H/L)	m³/min	7/6		8/6	11/8.5	14/11	16/12
	cfm	247/212		282/212	388/300	494/388	565/424
Sound level (H/L)	220 V	35/32		38/33	39/34	40/35	
	240 V	37/34		40/35	41/36	42/37	
Dimensions (H×W×D)	mm	600×1,000×222		600×1,140×222		600×1,420×222	
Machine weight	kg	25		30		36	
Piping connections	Liquid (Flare)	φ6.4				φ9.5	
	Gas (Flare)	φ12.7				φ15.9	
	Drain	210.D.					

Note: Specifications are based on the following conditions;
 • Cooling: Indoor temp.: 27°CDB, 19°CWB, Outdoor temp.: 35°CDB, Equivalent piping length: 7.5 m, Level difference: 0 m.
 • Capacity of indoor unit is only for reference. Actual capacity of indoor unit is based on the total capacity index. (See Engineering Data Book for details.)
 • Sound level: Anechoic chamber conversion value, measured at a point 1.5 m in front of the unit at a height of 1.5 m.
 During actual operation, these values are normally somewhat higher as a result of ambient conditions.

Concealed Floor Standing Type

FXNQ-MA

Designed to be concealed against the wall



- The unit is concealed against the wall, that enables to create high class interior design.
- The connecting port faces downward, greatly facilitating on-site piping work.
- A long-life filter (maintenance free up to one year*) is equipped as standard accessory.

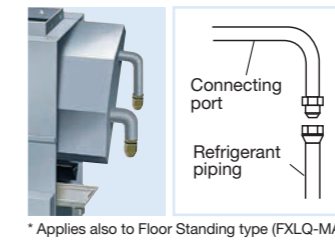

* 8 hr/day, 25 day/month. For dust concentration of 0.15 mg/m³

Specifications

MODEL		FXNQ20MAVE	FXNQ25MAVE	FXNQ32MAVE	FXNQ40MAVE	FXNQ50MAVE	FXNQ63MAVE
Power supply		1-phase, 220-240 V/220 V, 50/60 Hz					
Cooling capacity	Btu/h	7,500	9,600	12,300	15,400	19,100	24,200
	kW	2.2	2.8	3.6	4.5	5.6	7.1
Power consumption	kW	0.049		0.090		0.110	
Casing		Galvanised steel plate					
Airflow rate (H/L)	m³/min	7/6		8/6	11/8.5	14/11	16/12
	cfm	247/212		282/212	388/300	494/388	565/424
Sound level (H/L)	220 V	35/32		38/33	39/34	40/35	
	240 V	37/34		40/35	41/36	42/37	
Dimensions (H×W×D)	mm	610×930×220		610×1,070×220		610×1,350×220	
Machine weight	kg	19		23		27	
Piping connections	Liquid (Flare)	φ6.4				φ9.5	
	Gas (Flare)	φ12.7				φ15.9	
	Drain	210.D.					

Note: Specifications are based on the following conditions;
 • Cooling: Indoor temp.: 27°CDB, 19°CWB, Outdoor temp.: 35°CDB, Equivalent piping length: 7.5 m, Level difference: 0 m.
 • Capacity of indoor unit is only for reference. Actual capacity of indoor unit is based on the total capacity index. (See Engineering Data Book for details.)
 • Sound level: Anechoic chamber conversion value, measured at a point 1.5 m in front of the unit at a height of 1.5 m.
 During actual operation, these values are normally somewhat higher as a result of ambient conditions.

Air Treatment Equipment Lineup

Daikin's air treatment systems creating a higher air quality environment

Components of Indoor Air Quality

*Refers to processing outdoor air close to indoor temperatures and distributing it indoor.

A recent trend rapidly gaining popularity is for air treatment to be required as well as air conditioning. Daikin's Outdoor-Air Processing Unit can combine fresh air treatment and air conditioning, supplied from a single system. It adjusts the temperature of air from outdoors using a fixed discharge temperature control. Along with Outdoor-Air Processing Units, we also offer Heat Reclaim Ventilator systems. The Heat Reclaim Ventilator VAM series units in particular have been praised for their compactness, energy conservation and extensive operation range of outdoor temperatures. This series provides higher enthalpy efficiency, due to the greatly enhanced performance of the thin film element. Furthermore, improved external static pressure offers more flexibility for installation. The Heat Reclaim Ventilator VKM series units, equipped with a DX-coil, provide further advanced features, such as temperature adjustment to suit conditions indoors and to prevent hot air from blowing on people directly during cooling operation. The series also realises significant energy savings by exercising heat recovery.

		Outdoor-Air Processing Unit	Heat Reclaim Ventilator	
			VKM Type	VAM Type
Connections with VRV system	Refrigerant Piping	Connectable	Connectable	Not connectable
	Wiring	Connectable	Connectable	Connectable
	After-cool Control	Available	Available	Not available
Heat Exchange Element		—	Energy savings obtained	Energy savings obtained
High Efficiency Filter		Option	Option	Option
Ventilation System		Air supply only	Air supply & air exhaust	Air supply & air exhaust
Power Supply		220-240 V, 50 Hz	220-240 V, 50 Hz	220-240 V/220 V, 50 Hz/60 Hz
Airflow Rate				150 m ³ /h
				250 m ³ /h
			500 m ³ /h	350 m ³ /h
				500 m ³ /h
				650 m ³ /h
			800 m ³ /h	800 m ³ /h
			1000 m ³ /h	1000 m ³ /h
			1080 m ³ /h 1680 m ³ /h 2100 m ³ /h	1500 m ³ /h 2000 m ³ /h

*Refers to processing outdoor air close to indoor temperatures and distributing it indoor.

Air Treatment Equipment Lineup

Outdoor-Air Processing Unit

Combine fresh air treatment and air conditioning, supplied from a single system.

Lineup

Model Name	FXMQ125MFV1	FXMQ200MFV1	FXMQ250MFV1
Capacity Index	125	200	250



Fresh air treatment and air conditioning can be achieved with a single system by using heat pump technology—without the usual troublesome air supply and air discharge balance design. Fan coil units for air conditioning and an outdoor-air processing unit can be connected to the same refrigerant line. This results in enhanced design flexibility and significant reduction in total system costs.

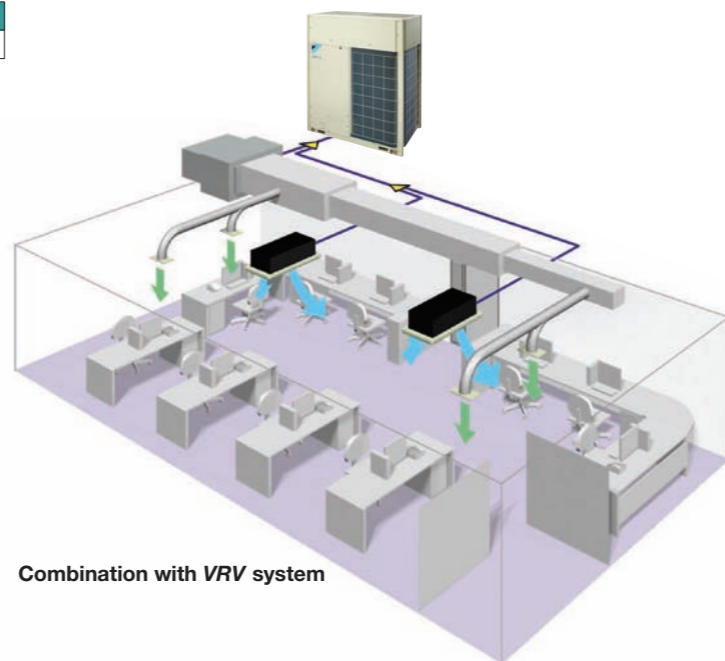

Combination with VRV system

Air conditioning and outdoor air processing can be accomplished using a single system.

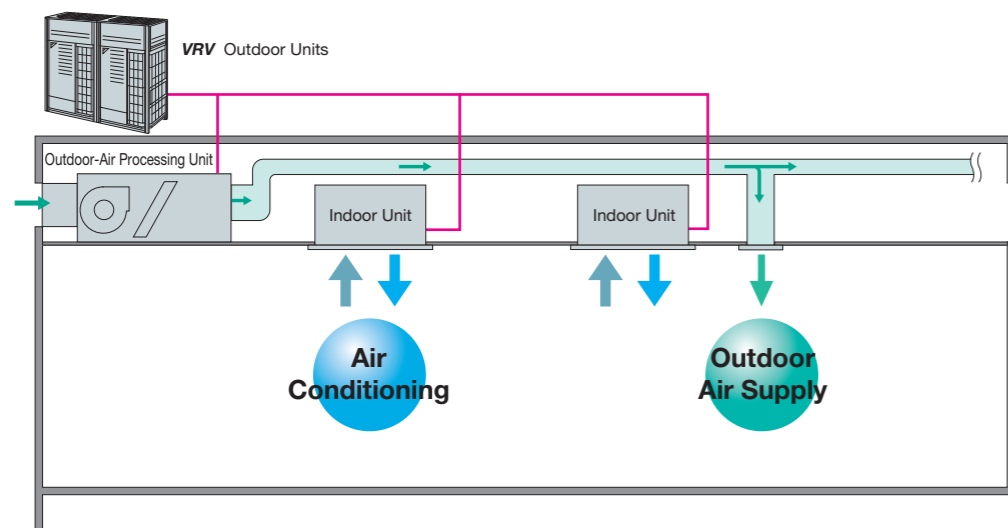

Connection Conditions

The following restrictions must be observed in order to maintain the indoor units connected to the same system.

- When outdoor-air processing units are connected, the total connection capacity index must be 50% to 100% of the capacity index of the outdoor units.
- When outdoor-air processing units and standard indoor units are connected, the total connection capacity index of the outdoor-air processing units must not exceed 30% of the capacity index of the outdoor units. Because connection is possible depending on conditions even when the capacity index of outdoor-air processing units exceeds 30% of the capacity index of the outdoor units, contact your local distributor.
- Outdoor-air processing units can be used without indoor units.

- The unit introduces outdoor air and adjusts the outdoor air temperature via fixed discharge temperature control, thereby reducing the air conditioning load.
- * The system can operate with outdoor-air temperatures ranging from -5 to 43°C. Heating performance is somewhat adversely affected when the outdoor-air temperature is 0°C or below.
- * When shipped from the factory, the thermostat is set at 18°C for cooling. The set temperature can be varied within the range of 13–25°C during cooling operation, in the local setting mode using the wired remote controller. The temperature, however, is not displayed on the remote controller.
- * While in machine protection mode and depending on outdoor air conditions, discharge air temperature may not be at the set temperature.
- * The fan stops when operating in defrosting, oil returning and hot start operations. The fan may stop due to mechanical protection control.

- Ceiling mounted duct units with three different capacities are available. These can be connected to VRV series outdoor units to meet a variety of different requirements.

Airflow rate

FXMQ125MFV1	1,080 m ³ /h
FXMQ200MFV1	1,680 m ³ /h
FXMQ250MFV1	2,100 m ³ /h

- Optional equipment includes long-life filters.
- Compatible with outdoor temperatures from -5°C to 43°C.

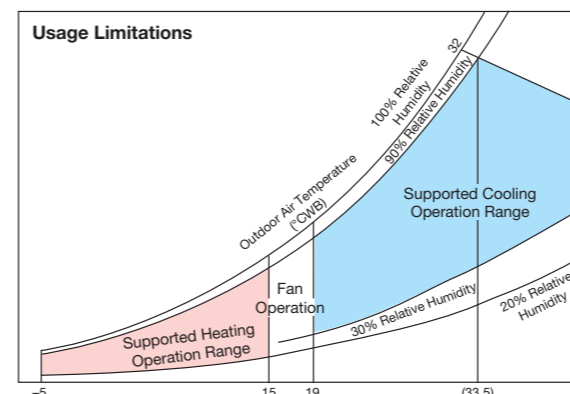

Note:

1. The data shown in the graph illustrates the supported operation ranges under the following conditions.
Indoor and Outdoor Unit
Effective piping length: 7.5 m
Height differential: 0 m
2. The discharge temperature can be set using the remote controller. However, the actual temperature may not match the temperature setting under some circumstances due to the outdoor-air processing load or mechanical protection controls.
3. The system will not operate in fan mode when the outdoor air temperature is 5°C or below.

- High-performance filters with dust collection efficiencies (JIS calorimetry) of 90% and 65% are also available as options.

- For the VRV system, a variety of control systems can be deployed, including remote control from distances of up to 500 m.



BRC1E63
Navigation Remote Controller (Wired remote controller) (option)

- * Group control is not possible between this unit and standard type indoor units. Remote controllers connect to each unit separately.

- The “self-diagnosis function” indicates the occurrence and nature of abnormalities in the system by displaying codes on the remote controller.

- A central control system compatible with the VRV system can be installed.



DCS302CA61
Central remote controller (option)

- * It is not possible to change the discharge air temperature settings from the central control system.
- * Do not associate this equipment in areas which standard indoor units are installed, as central control cannot be used with them.

- With the VRV system, the equipment employs the “super wiring system” so that the wiring linking the indoor and outdoor units can also be utilised for central control.

Note:

- Linked control of the product and the Heat Reclaim Ventilator is not supported.
- This equipment is intended for the treatment of outdoor air only. It is not to be used for maintaining indoor air temperature. Installing or use with standard indoor units. Be sure to position the air discharge openings of the product in positions where the airflow will not blow on people directly. When outdoor-air processing is in excess, the unit switches to thermo-off mode, and outdoor air flows into the room directly.
- For outdoor ducts, be sure to provide heat insulation to prevent condensation.
- Group control of the product and standard indoor units is not supported. A separate remote controller should be connected to individual unit.
- The system will not operate in fan mode when the outdoor air temperature is 5°C or below.
- If the product is utilised to operate 24 hours a day, maintenance (part replacement, etc.) must be performed periodically.
- Temperature setting and Power Proportional Distribution (PPD) are not possible even if the intelligent Touch Controller or the intelligent Touch Manager is installed.
- The remote controller wired to the outdoor-air processing unit must not be set as the master remote controller. Otherwise, when set to “Auto,” the operation mode will switch according to the outdoor air conditions, regardless of the indoor temperature.

Air Treatment Equipment Lineup

Standard Specifications

Indoor unit

Type		Ceiling Mounted Duct Type		
Model		FXMQ125MFV1	FXMQ200MFV1	FXMQ250MFV1
Power supply		1-phase 220-240 V (also required for indoor units), 50 Hz		
Cooling capacity *1	Btu/h	47,800	76,400	95,500
	kW	14.0	22.4	28.0
Power consumption	kW	0.359	0.548	0.638
Casing		Galvanised steel plate		
Dimensions (HxWxD)		470X744X1,100		470X1,380X1,100
Fan	Motor output	0.380		
	Airflow rate	m ³ /min	18	28
		cfm	635	988
External static pressure	220V/240V	Pa	185/225	225/275
Air filter		*2		
Refrigerant piping	Liquid	mm	φ 9.5 (flare)	
	Gas	mm	φ 15.9 (flare)	φ 19.1 (brazing)
	Drain	mm	PS1B female thread	
Machine weight		kg	86	123
Sound level *3	220V/240V	dB(A)	42/43	47/48
Connectable outdoor units *4			6 HP and above	8 HP and above
Operation range (Fan mode operation between 15 and 19°C)		Cooling	19 to 43°C	
Range of the discharge temperature *5		Cooling	13 to 25°C	

Note : *1. Specifications are based on the following conditions:
 • Cooling: Outdoor temp. of 33°CDB, 28°CWB (68% RH), and discharge temp. of 18°CDB.
 • Equivalent reference piping length: 7.5 m (0 m horizontal)
 *2. An intake filter is not supplied, so be sure to install the optional long-life filter or high-efficiency filter. Please mount it in the duct system of the suction side. Select a dust collection efficiency (gravity method) of 50% or more.
 *3. Anechoic chamber conversion value, measured at a point 1.5 m downward from the unit centre. These values are normally somewhat higher during actual operation as a result of ambient conditions.
 *4. It is possible to connect to the outdoor unit if the total capacity of the indoor units is 50% to 100% of the capacity index of the outdoor unit.
 *5. Local setting mode is not displayed on the remote controller.
 • This equipment cannot be incorporated into the remote group control of the VRF system.

Options

Indoor unit

Model		FXMQ125MFV1	FXMQ200MFV1	FXMQ250MFV1	
Operation/control	Operation remote controller	BRC1E63 / BRC2E61			
	Central remote controller	DCS302CA61			
	Unified ON/OFF controller	DCS301BA61			
	Schedule timer	DST301BA61			
	Wiring adaptor for electrical appendices (1)	KRP2A61			
Filters	Wiring adaptor for electrical appendices (2)	KRP4AA51			
	Long-life replacement filter	KAFJ371L140	KAFJ371M280		
	High-efficiency filter	Colourimetric method 65%	KAFJ372L140	KAFJ372M280	
		Colourimetric method 90%	KAFJ373L140	KAFJ373M280	
	Filter chamber *1	KDJ3705L140	KDJ3705L280		
PM2.5 filtration unit *2		BAF429A20A			
PM2.5 with activated carbon filtration unit *2		BAF429A20AC			
Drain pump kit		KDU30L250VE			
Adaptor for wiring		KRP1B61			

Note : *1. Filter chamber has a suction-type flange. (Main unit does not.)
 • Dimensions and weight of the equipment may vary depending on the options used.
 • Some options may not be usable due to the equipment installation conditions, so please confirm prior to ordering.
 *2. Refer to page 68-70 for details.
 • Some options may not be used in combination.
 • Operating sound may increase somewhat depending on the options used.

Dimensions

FXMQ125/200/250MFV1

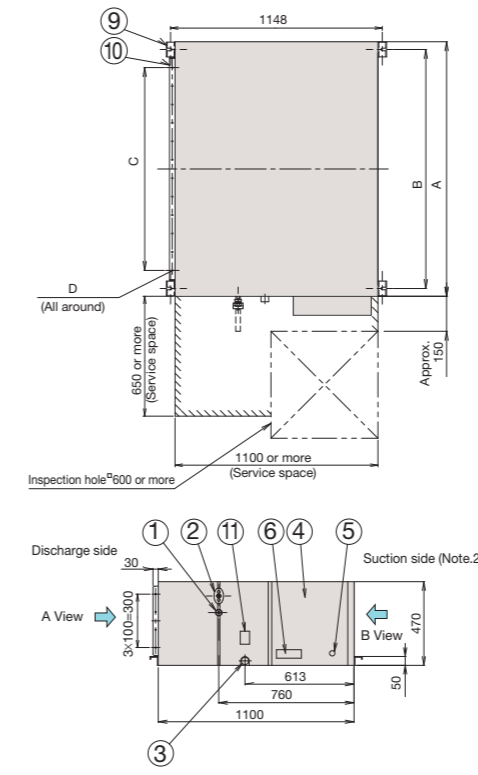

*These diagrams are based on FXMQ200 and FXMQ250MFV1.

Local connection piping size

Model	Gas piping diameter	Liquid piping diameter
FXMQ125MFV1	φ15.9	φ9.5
FXMQ200MFV1	φ19.1 attached piping	φ9.5
FXMQ250MFV1	φ22.2 attached piping	φ9.5

Table of dimensions

Model	A	B	C	D
FXMQ125MFV1	744	685	5X100=500	20-φ4.7 hole
FXMQ200MFV1	1380	1296	11X100=1100	32-φ4.7 hole
FXMQ250MFV1	1380	1296	11X100=1100	32-φ4.7 hole

Note:
 1. The attached piping in the diagram is for FXMQ200MFV1 and FXMQ250MFV1 only. The gas piping connection port (② in the diagram) has a different bore form with FXMQ125MFV1.
 2. An air filter is not supplied with this unit. Be sure to mount an air filter in the suction side. [Use a filter with dust collection efficiency of at least 50% (gravimetric method). This is available as an option.]
 3. For outdoor ducts, be sure to provide heat insulation to prevent condensation.

- ① Liquid pipe connection
- ② Gas pipe connection
- ③ Drain piping connection
- ④ Electric parts box
- ⑤ Ground terminal
- ⑥ Name plate
- ⑦ Power supply wiring connection
- ⑧ Transmission wiring connection
- ⑨ Hanger bracket
- ⑩ Discharge companion flange
- ⑪ Water supply port
- ⑫ Attached piping (Note. 1)

FXMQ200/250MFV1

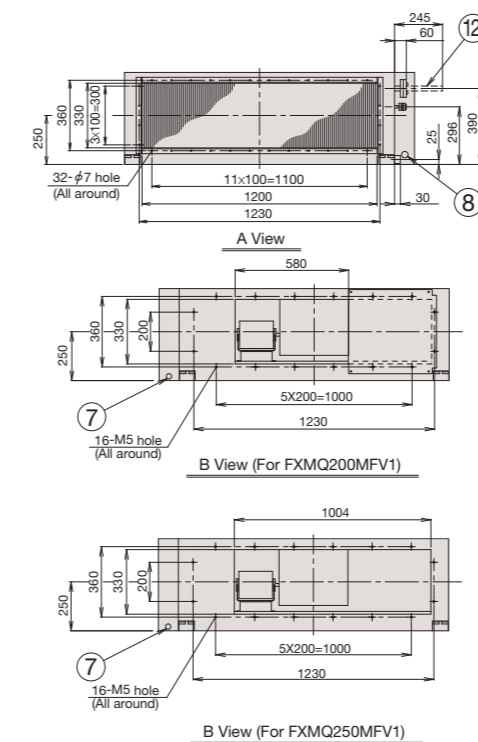

FXMQ125MFV1

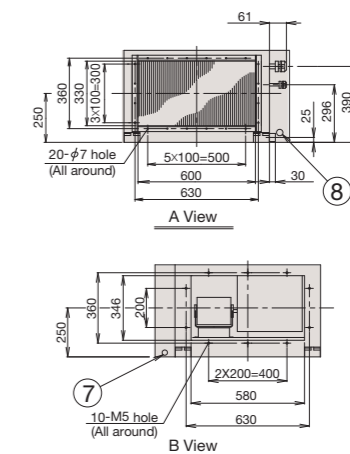

Control Systems

Individual control systems for VRV systems

Stylish remote controller (Option) New



BRC1H62W (White)



BRC1H62K (Black)

A complete redesigned controller focused to enhance user experience



Sleek and stylish design

- Combines refinement and simplicity
- Echoes the distinct blue circle and simplicity of design
- Two attractive colours to match any interior
- Compact, measures only 85 x 85 mm



User-friendly interface

- Just three buttons and a large-figure display
- Customisable display
- Direct access to basic functions (ON/OFF, Operation mode, Temperature setting, Airflow rate, Airflow direction)



Easy setting via Bluetooth App with smartphone (for Installer / Facility manager)

Keep hotel room comfortable

- Improved setback function by setting the lower temperature limit in cooling and higher temperature in heating mode.

Shorter installation time

- Easy to create multiple remote control and field settings via App
- Prepare a setting in advance at the office and immediately send it to the on-site remote controller
- Save and reuse settings

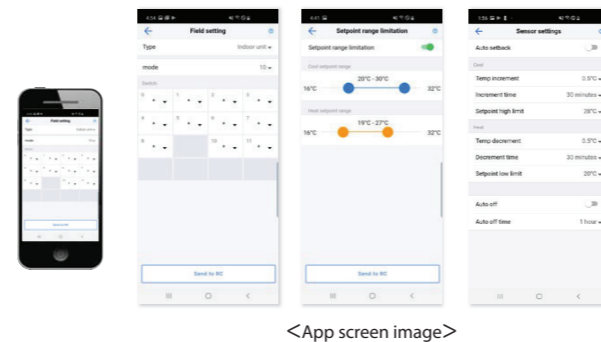

<App screen image>

Navigation remote controller (Wired remote controller) (Option)



BRC1E63

A series of user friendly functions that can be individually selected

Energy saving

Setpoint range set

- Avoids excessive cooling or heating by limiting the min. and max. set temperature.
- Convenient for use at a place where any number of people may operate it.

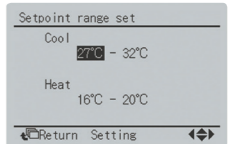

Setpoint auto reset

- Even if the set temperature is changed, the new set temperature returns to the previous preset value after a preset duration of time.
- Period selectable from 30, 60, 90, or 120 min.

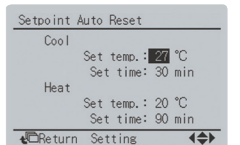

Off timer

- Period can be preset from 30 to 180 minutes in 10-minute increments.

Convenience

Setback (default: OFF)

- Maintains the room temperature in a specific range during unoccupied period by temporarily starting air conditioner that was turned OFF.

Weekly schedule

- 5 actions per day can be scheduled for each day of the week.
- The holiday function will disable schedule timer for the days that have been set as holiday.
- 3 independent schedules can be set. (e.g. summer, winter, mid-season)

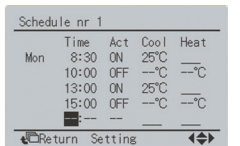

Auto display off

- Period can be preset from 10, 30, 60 minutes, and OFF. Initial setting is 30 minutes.

Comfort

Individual airflow direction

- Airflow direction can be individually adjusted for each air discharge outlet.

5-step airflow control

- Airflow rate can be selected from 5-step control.

Auto airflow rate

- Airflow rate is automatically controlled.

Individual Control Systems for VRV Systems

Simplified remote controller (Option)



BRC2E61

Easy operation with new intuitive design

Simple operation

- Using only six buttons, users have direct access to basic functions. This enables them to easily set comfort to their preference.

- ON/OFF -Operation mode
- Temperature setting
- Airflow rate (5-step & Auto)*
- Up and down airflow direction (5-step & Swing)*
- ON/OFF timer

* The number of airflow steps and availability of auto airflow rate and swing mode depend on the type of indoor unit.



Intuitive design

- By using pictograms, the user-friendly interface enables convenient and easy operation.

Compact size

- Measuring only 85 x 85 mm, the new remote controller is extremely compact and complements any interior design.

Wireless remote controller (Option)



Signal receiver unit (Installed type)

BRC-M series

- The wireless remote controller is supplied in a set with a signal receiver.
- Signal receiver unit of installed type is contained inside decoration panel or indoor unit.
- Shape of signal receiver unit differs according to the indoor unit.
Note: The signal receiver unit shown in the photograph is for mounting inside the decoration panel of FXF(S)Q series.

- Backlight LCD of new wireless remote controller



Pressing the backlight button helps operating in dark rooms.

- A compact signal receiver unit (separate type) to be mounted into a wall or ceiling is included.

* Wireless remote controller and signal receiver unit are sold as a set.
* Refer to page 90 for the name of each model.



Signal receiver unit (Separate type)

BRC-C, E series

Wide variation of remote controllers for VRV indoor units

	FXFSQ	FXFQ	FXZQ	FXUQ	FXCQ	FXKQ	FXDQ	FXSQ	FXMQ	FXHQ	FXAQ	FXL(N)Q
Navigation remote controller (BRC1E63)	●	●	●	●	●	●	●	●	●	●	●	●
Simplified remote controller (BRC2E61)		●	●	●	●	●	●	●	●	●	●	●
Wireless remote controller* (Installed type signal receiver unit)	●	●	●	●	●					●	●	
Wireless remote controller* (Separate type signal receiver unit)						●	●	●	●			●

*Refer to page 90 for the name of each model.

The wired remote controller supports a wide range of control functions

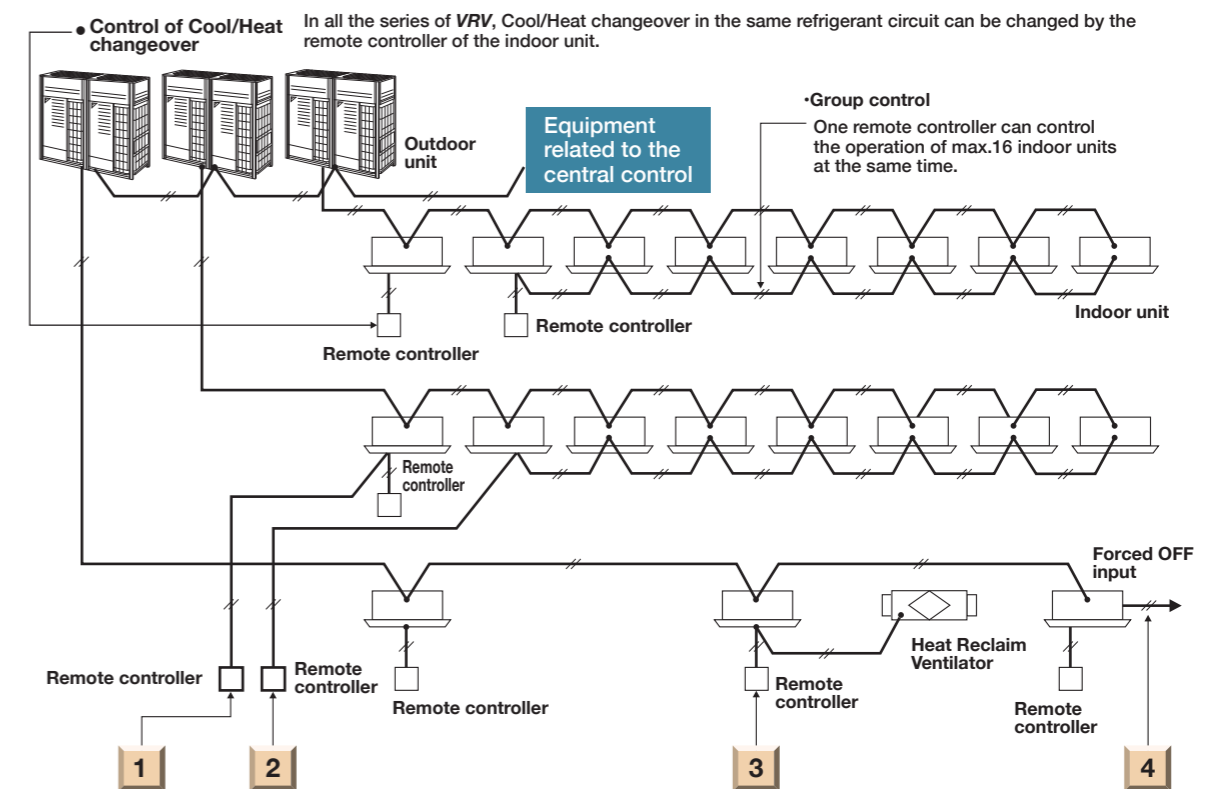

Integrated Building Monitoring System

The high speed transmission of DIII-NET enables more advanced control of the VRV system, providing you with enhanced comfort.

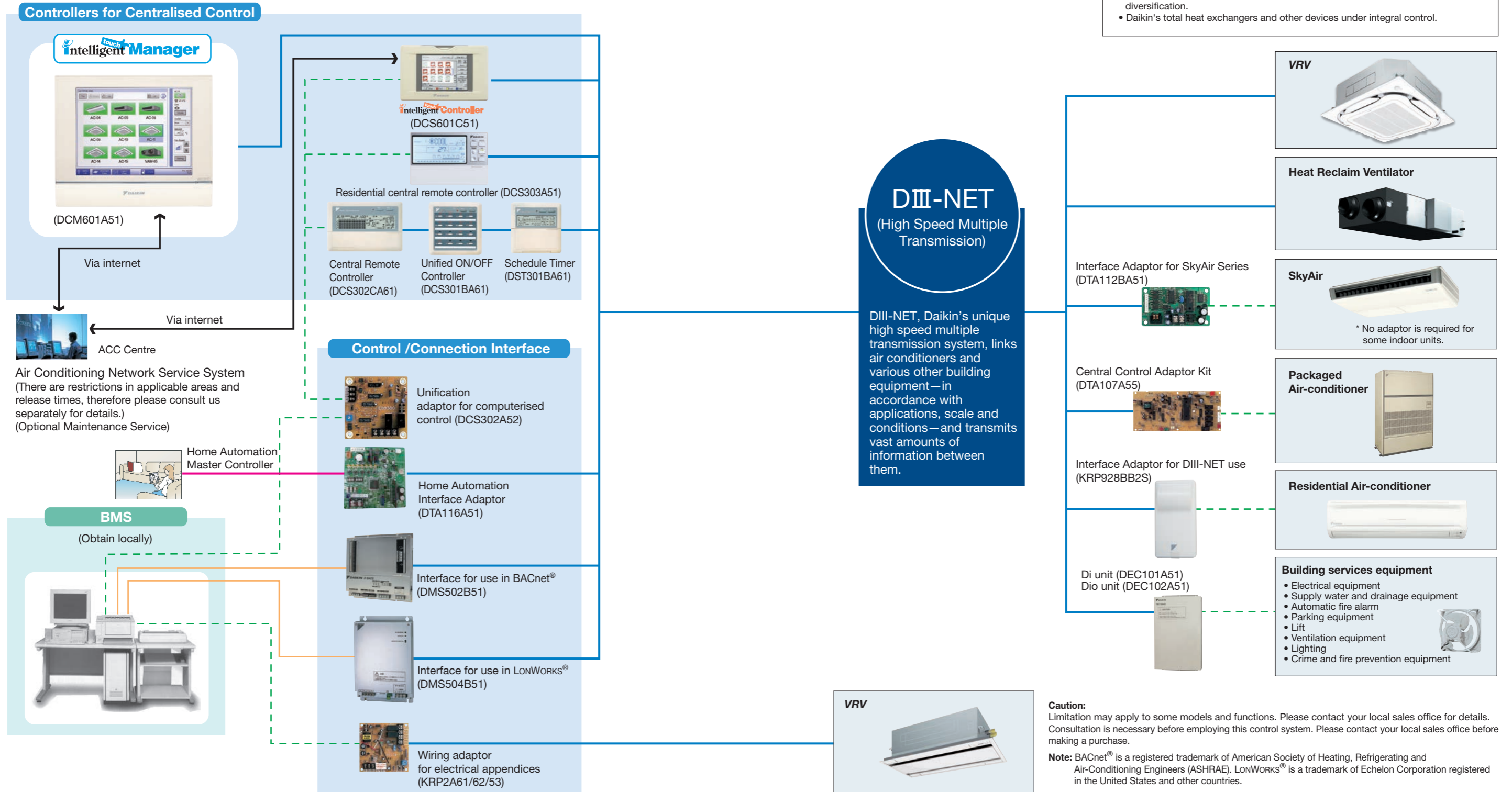

Advanced Control Systems for VRF Systems



One touch selection enables flexible control of equipment in a building.



DCM601A51

Various types of equipment in a building can be controlled by a single controller.

Individual air-conditioning control

The flexible control achieved by the VRF system precisely meets different air conditioning needs in each room (e.g. offices, conference rooms, hotel rooms).



Lighting control

DALI-compatible

DALI-compatible LED lighting systems can be controlled and monitored. Lighting control is enhanced through an interlock function with air conditioners and other functions.

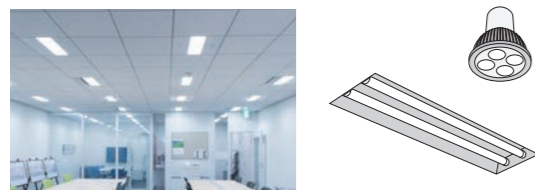

Air-conditioning control for large spaces

Air handling units can also be controlled. Large spaces, such as entrance halls and shopping malls, can be easily controlled to ensure comfort.

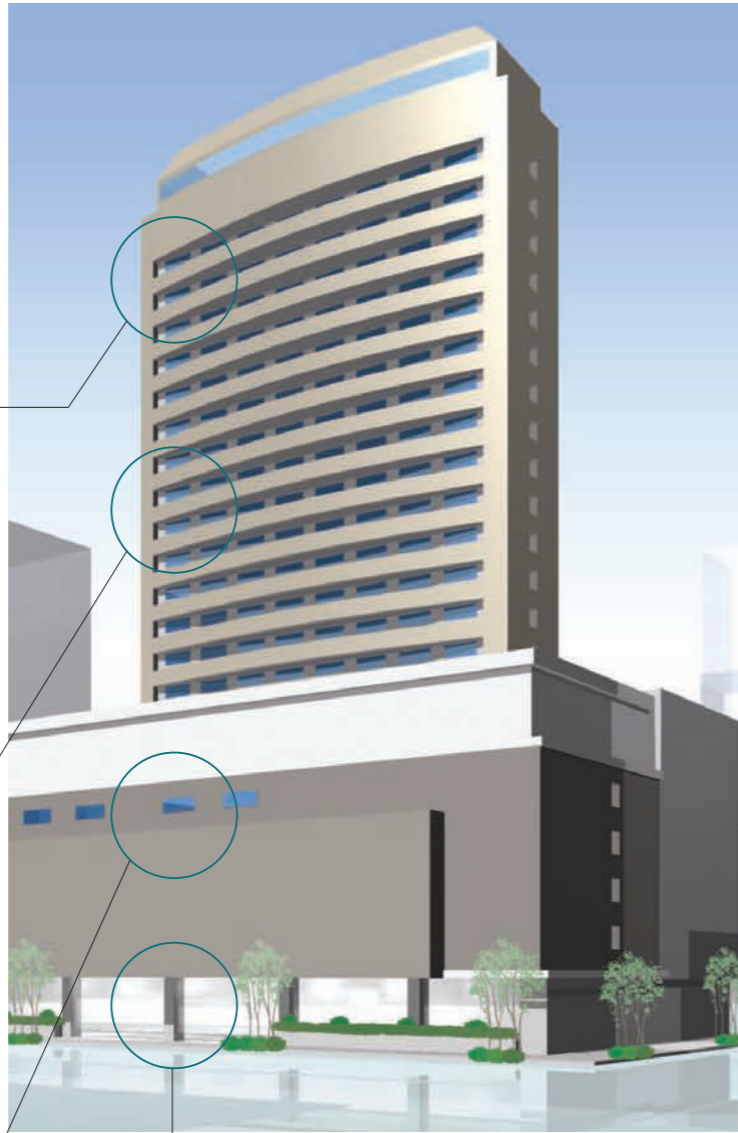

Building equipment control

Various types of equipment other than air conditioners, including ventilators, fans, and pumps, can also be controlled.



Pump



Fan

For Energy Saving & Comfort

intelligent Touch Manager maximises the advantages of VRF features

intelligent Touch Manager is an advanced multi-zone controller that provides the most cost-effective way to control and monitor the Daikin VRF system.

The 10.4" LCD touch screen is easy to use with three different screen views to include the floor plan layout view, icon view and list view and menus for system configurations.

It is also easy to use with standardized remote Web Access from your PC.

It can manage a total of 650 management points consisting of up to 512 Daikin indoor unit groups (up to 1024 indoor units) along with building equipment control / monitoring with Digital Inputs / Output (Di/Dio), Analog Inputs / Output (Ai/Ao) and Pulse input (Pi) optional devices.

Schedule the operation time for each application.	Define the setpoint range that users can change.
	<p>With Remote controller</p> <p>With Control System</p>
<p>Turn the unit OFF if a user didn't.</p>	<p>Reset setpoint regularly.</p>

Advanced Control Systems for VRV Systems

In addition to switching lights on and off, advanced lighting control, such as illuminance adjustment, can be achieved

Lighting control (Option)

Connection to DALI - compatible lighting control system

Simple wiring (daisy chain) enables management of LED lighting by the *intelligent Touch Manager*.

Various air conditioning and lighting control is enabled through the interlock with occupancy sensors and illuminance sensors.

DALI-compatible

Please contact your local sales office for details.

Lighting control achieved by the *intelligent Touch Manager*

[Operation]

- Switch-on/switch-off operation
- Illuminance (1–100%) control
- Various illuminance patterns can be registered
- Registered pattern can be selected from *intelligent Touch Manager*

[Monitoring]

- Switch-on/switch-off status monitoring
- Lighting abnormality monitoring
- Illuminance monitoring
- DALI occupancy sensor monitoring
- DALI illuminance sensor monitoring

Air conditioning and lighting for which power consumption is high can be efficiently controlled to promote energy conservation and cost reduction!

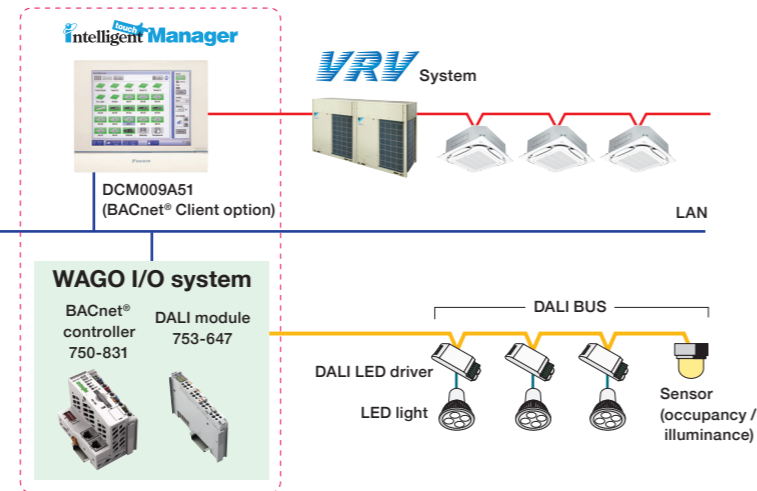

[Overview of control]

- Up to 5 DALI modules can be connected to a single BACnet® controller.
- Up to 64 DALI LED drivers (64 addresses) can be connected to a single DALI module.
- 64 DALI addresses can be freely assigned to up to 16 groups using a single DALI module. (Each group corresponds to a management point of the *intelligent Touch Manager*.)
- Up to 16 scenes can be set to a single DALI module.
- Up to 12 sensors (occupancy, illuminance) can be connected to a single DALI module.
- DALI BAS simplifies wiring and setting work by daisy chain wiring and automatic address setting.

Easy maintenance and energy saving by lighting control

Case1

Switch-on / switch-off and illuminance are controlled based on a schedule to cut wasteful power consumption.

- Failing to switch off lights is prevented.



- Optimal illuminance reduces energy.

Case2

Occupancy sensors are used to eliminate both wasteful lighting and air conditioning.

When a room is unoccupied, the air conditioning stops and the lighting is switched off.

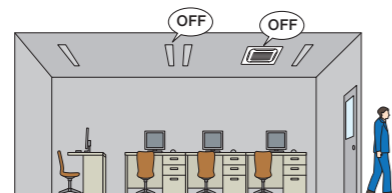

Case3

Lighting abnormalities (e.g. burned-out bulbs) can be checked on the *intelligent Touch Manager* screen.

Lighting maintenance becomes easier and quicker.

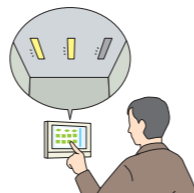

The layout screen enables quick identification of specific locations.

Tenant Management

Reporting the power consumption of VRV system for each tenant (PPD* Option)

With the PPD function, power consumption can be calculated for each indoor unit (Option)

The energy consumption is proportionally calculated for each indoor unit. The data can be used for energy management and calculation of air conditioning usage fees for respective tenants.

Operational information of individual indoor units are monitored, based on distribution of power consumption of outdoor units.

Daikin's PPD keeps track of power distribution for each indoor unit. It performs air conditioning billing calculations quickly and automatically.

It is easy to output PPD data.

PPD data is output in CSV format to a PC or USB memory device and can be freely processed and managed.

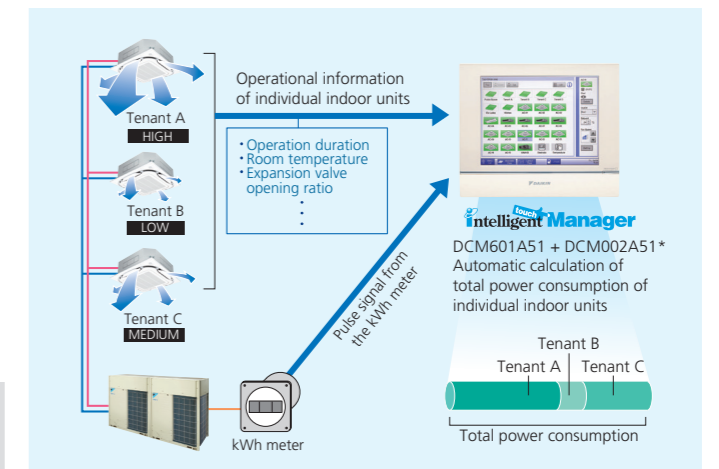

*PPD (Power Proportional Distribution) is Daikin's proprietary calculation method.

Air conditioning bills can be issued by one click (PPD* Option)

Electricity bills can be easily calculated for each tenant (Option)

The power consumption of VRV controlled by the *intelligent Touch Manager* can be easily managed for each tenant using a PC. The electricity bill settings facilitate billing work through easy calculation and issuance of VRV electricity bills.

Main functions

- Register tenants
- Set the electricity unit price for 5 time zones
- Calculate power consumption and electricity charge for each tenant
- Show aggregation results in the specified period for each tenant
- Output the results (Printout and CSV file)

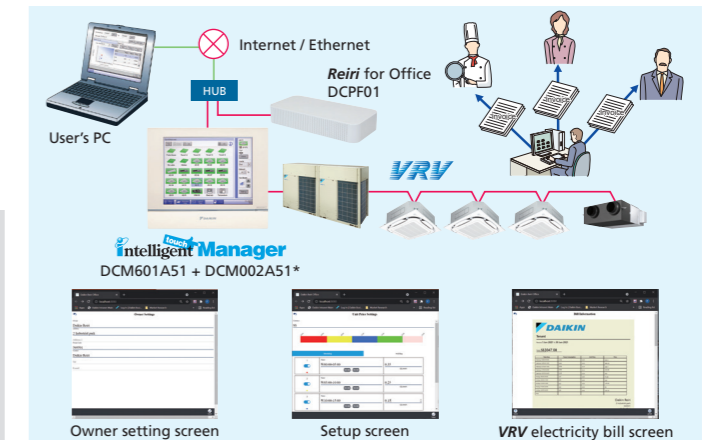

*PPD (Power Proportional Distribution) is Daikin's proprietary calculation method.

Effective service functions offered to tenants

Smartphone will be a remote controller of VRV system (Option)

Users can operate and check the status of VRV system from their smartphones via WiFi.

It is not necessary to move where a remote controller is located with this feature. VRV system in other rooms can be operated, and their status can be checked. It is also possible to check if air conditioners in other rooms remain switched on etc., helping achieve energy saving.

For buildings VRV Smartphone Remote Controller

Up to 1024 indoor units can be controlled.

Just add *Reiri for Office* DCPF01 to this system

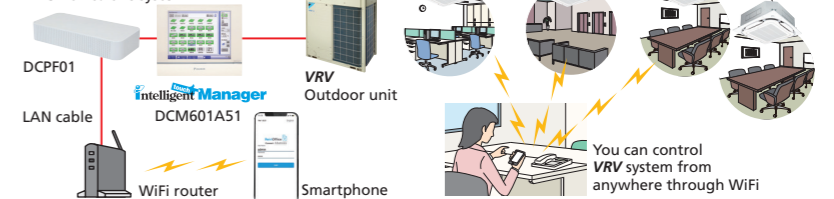

You can control VRV system from anywhere through WiFi

Intelligent Touch Manager system overview

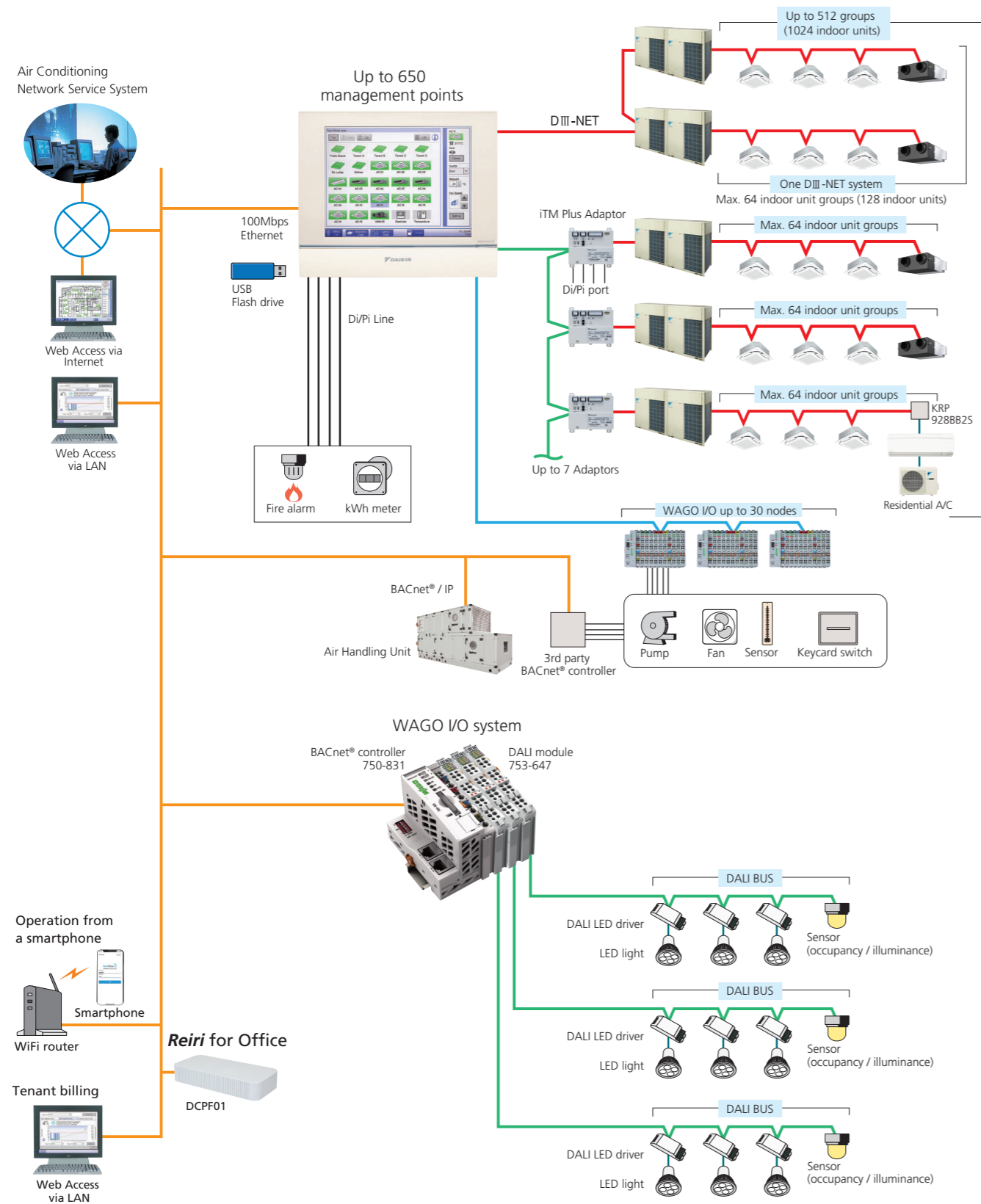

Air conditioning network service system

Preventive maintenance

The intelligent Touch Manager can be connected to Daikin's own Air Conditioning Network Service System for remote monitoring and verification of operation status for VRV system. By its ability to predict malfunctions, this service provides customers with additional peace of mind.

Enhanced convenience with link to the Air Conditioning Network Service System

The intelligent Touch Manager connects seamlessly to Daikin's 24-hour Air Conditioning Network Service System.

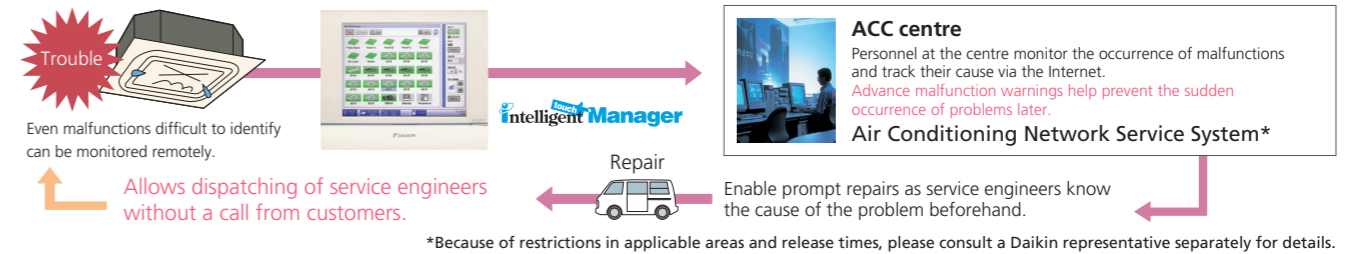

Daikin offers a variety of control systems

Convenient controllers that offer more freedom to administrators

Ease of use and expanded control functions

The user-friendly controller features colours, multilingual function, and icons in the display for ease of understanding. A wide variety of control methods can be accommodated, permitting administrators to monitor and operate the system even when they are away from the controller.



Connect VRV system to your BMS via BACnet® or LonWorks®

Compatible with BACnet® and LonWorks®, the two leading open network communication protocols, Daikin offers interfaces that provide a seamless connection between VRV system and your BMS.

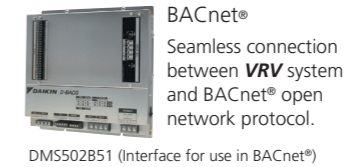

Dedicated interfaces make Daikin air conditioners freely compatible with open networks

Notes: 1. BACnet® is a registered trademark of American Society of Heating, Refrigerating and Air-Conditioning Engineers (ASHRAE).
2. LonWorks® is a trademark of Echelon Corporation registered in the United States and other countries.

New Specialised solution for office, home and hotel with Reiri Series

Catering to different applications, ranging from 10 indoor units to 2048 indoor units



- For Office Building Automation System
- For Home Smart Home Solution
- For Hotel Air Conditioning Guestroom Interlocking Management

- Reiri for Office (Touchscreen Controller)
- Reiri for Office (Controller Extension)
- Reiri for Office (Multisite Extension)
- Reiri for Home
- Reiri for Home (Lite Version)
- Reiri for Hotel
- Reiri for Resort

Home automation interface adaptor

The VRV system can be operated from the home automation system.

Image to use home automation interface adaptor DTA116A51

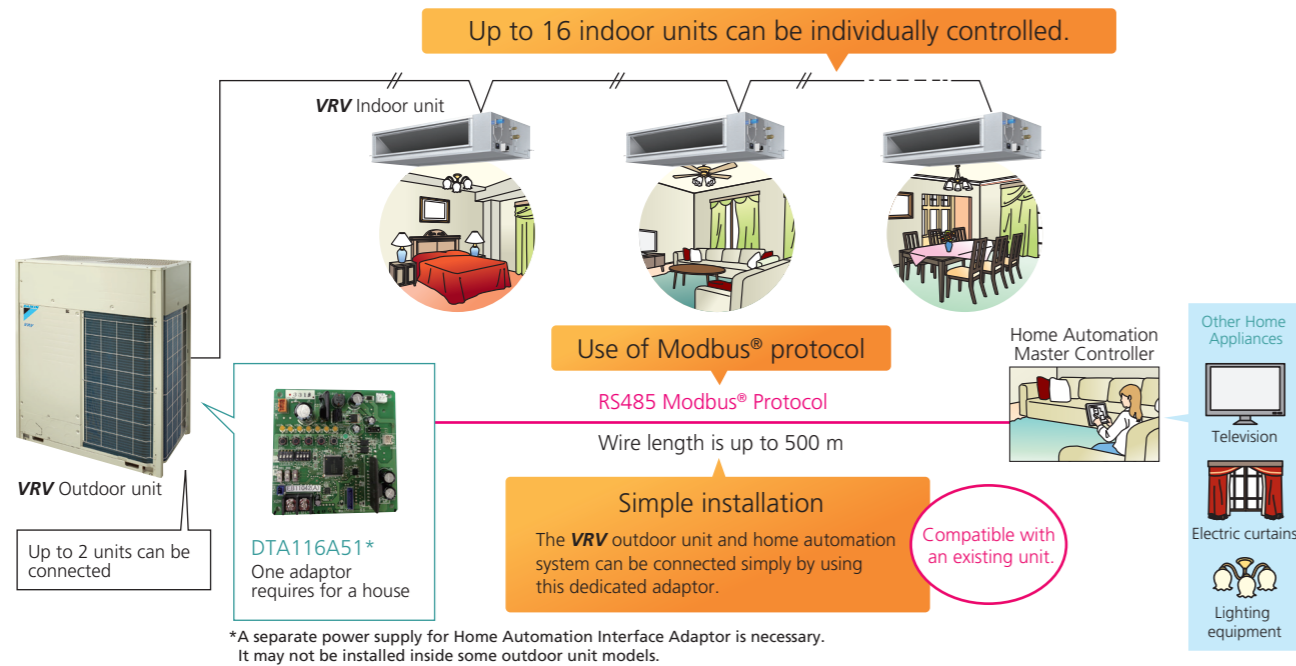

Functions Monitor

On/Off	On/Off status of indoor units
Operation mode	Cooling, Heating, Fan, Dry, Auto (depend on indoor unit capability)
Setpoint	Setpoint of indoor units
Room temperature	Suction temperature of indoor units
Fan direction	Swing, Flap direction (depend on indoor unit capability)
Fan volume	L, M, H (depend on indoor unit capability)
Forced off status	Forced off status of indoor units
Error	Malfunction, Warning with Error code
Filter sign	Filter sign of indoor units
Communication status	Communication normal/error of indoor units

Control

On/Off	On/Off control of indoor units
Operation mode	Cooling, Heating, Fan, Dry, Auto (depend on indoor unit capability)
Setpoint	Cooling/Heating setpoint
Fan direction	Swing, Stop, Flap direction (depend on indoor unit capability)
Fan volume	L, M, H (depend on indoor unit capability)
Filter sign reset	Reset filter sign of indoor units

Retrieve system information

Connected indoor units	DIII -NET address of connected indoor units can be retrieved.
Indoor unit capabilities	Indoor unit capabilities such as operation mode, fan control, setpoint HV can be retrieved.

VRV Smartphone Control System

VRV Smartphone Control System can be realized by *Reiri* which is a new product to utilize DCPA01.



Outdoor Units

No.	Item		Type	RXQ6A(W) RXQ8A(W) RXQ10A(W)	RXQ12A(W) RXQ14A(W) RXQ16A(W)
1	Distributive piping	REFNET header		KHRP26M22H, KHRP26M33H (Max. 4 branch) (Max. 8 branch)	KHRP26M22H, KHRP26M33H, KHRP26M72H (Max. 4 branch) (Max. 8 branch) (Max. 8 branch)
		REFNET joint		KHRP26A22T, KHRP26A33T	KHRP26A22T, KHRP26A33T, KHRP26A72T

No.	Item		Type	RXQ18AM(W) RXQ20AM(W) RXQ22AM(W) RXQ24AM(W)	RXQ26AM(W) RXQ28AM(W) RXQ30AM(W) RXQ32AM(W)	RXQ34AM(W) RXQ36AM(W) RXQ38AM(W) RXQ40AM(W)	RXQ42AM(W) RXQ44AM(W) RXQ46AM(W) RXQ48AM(W)
1	Distributive piping	REFNET header		KHRP26M22H, KHRP26M33H, KHRP26M72H, KHRP26M73H (Max. 4 branch) (Max. 8 branch) (Max. 8 branch) (Max. 8 branch)			
		REFNET joint		KHRP26A22T, KHRP26A33T, KHRP26A72T, KHRP26A73T			
2	Pipe size reducer			KHRP26M73TP, KHRP26M73HP			
3	Outdoor unit multi connection piping kit			BHFP22P100		BHFP22P151	

REFNET joint (KHRP26A22/33/72/73T)

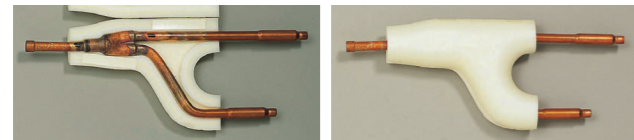

Option PCB

No.	Item		Type	RXQ6A(W) RXQ8A(W) RXQ10A(W) RXQ12A(W)	RXQ14A(W) RXQ16A(W)	RXQ18AM(W) RXQ20AM(W) RXQ22AM(W) RXQ24AM(W)	RXQ26AM(W) RXQ28AM(W) RXQ30AM(W) RXQ32AM(W)
1	DIII-NET expander adaptor ★			DTA109A51			
2	External control adaptor ★			DTA104A61			
3	Home Automation Interface Adaptor ★			DTA116A51			
4	Option plate for control adaptor			—	BKS26A *1	—	BKS26A *1

No.	Item		Type	RXQ34AM(W) RXQ36AM(W)	RXQ38AM(W) RXQ40AM(W) RXQ42AM(W)	RXQ44AM(W) RXQ46AM(W) RXQ48AM(W)
1	DIII-NET expander adaptor ★			DTA109A51		
2	External control adaptor ★			DTA104A61		
3	Home Automation Interface Adaptor ★			DTA116A51		
4	Option plate for control adaptor			—	BKS26A *1	

Note: *1. This plate is necessary for each adaptor marked ★.

Indoor Units

Ceiling Mounted Cassette (Round Flow with Sensing) Type



No.	Item		Type	FXFSQ25A FXFSQ32A FXFSQ40A	FXFSQ50A FXFSQ63A FXFSQ80A	FXFSQ100A FXFSQ125A FXFSQ140A
1	Decoration panel	Standard panel with sensing	Fresh white	BYCQ125EEF		
			Black	BYCQ125EEK		
		Standard panel	Fresh white	BYCQ125EAF *		
			Black	BYCQ125EAK *		
Designer panel ¹	Fresh white	BYCQ125EAPF *				
	Auto grille panel ^{2,3}	Fresh white	BYCQ125EBSF			
2	Sealing material of air discharge outlet		For usage of 3-, 4-way flow	KDBH551C160		
			For usage of 2-way flow	KDBH552C160		
3	Panel spacer			KDB55J160F		
4	Fresh air intake kit		Chamber type ^{5,6}	KDDP55B160 (Components: KDDP55C160-1, KDDP55B160-2) ⁸		
			Without T-duct joint	KDDP55B160K (Components: KDDP55C160-1, KDDP55B160K2) ⁹		
			With T-duct joint	KDDP55X160A		
5	High-efficiency filter unit ⁹ (Including filter chamber)		(Colorimetric method 65%)	KAF556D80	KAF556D160	
			(Colorimetric method 90%)	KAF557D80	KAF557D160	
6	Replacement high-efficiency filter ^{9,10}		(Colorimetric method 65%)	KAF552D80	KAF552D160	
			(Colorimetric method 90%)	KAF553D80	KAF553D160	
7	Filter chamber			KDDFP55C160		
8	Replacement long-life filter			KAF5511D160		
9	Replacement long-life filter (Auto grille panel)			KAF5512D160		
10	Ultra long-life filter unit (Including filter chamber) ⁹			KAF555D160		
11	Replacement ultra long-life filter ^{9,10}			KAF550D160		
12	Branch duct chamber ⁴			KDJP55C80	KDJP55C160	
13	Insulation kit for high humidity ^{9,11}			KDTP55K80A	KDTP55K160A	

Ceiling Mounted Cassette (Round Flow) Type



No.	Item		Type	FXFQ25A FXFQ32A FXFQ40A	FXFQ50A FXFQ63A FXFQ80A	FXFQ100A FXFQ125A FXFQ140A
1	Decoration panel	Standard panel	Fresh white	BYCQ125EAF *		
			Black	BYCQ125EAK *		
		Designer panel ¹	Fresh white	BYCQ125EAPF *		
			Auto grille panel ^{2,3}	Fresh white	BYCQ125EBSF	
2	Sealing material of air discharge outlet		For usage of 3-, 4-way flow	KDBH551C160		
			For usage of 2-way flow	KDBH552C160		
3	Panel spacer			KDB55J160F		
4	Fresh air intake kit		Chamber type ^{5,6}	KDDP55B160 (Components: KDDP55C160-1, KDDP55B160-2) ⁸		
			Without T-duct joint	KDDP55B160K (Components: KDDP55C160-1, KDDP55B160K2) ⁹		
			With T-duct joint	KDDP55X160A		
5	High-efficiency filter unit ⁹ (Including filter chamber)		(Colorimetric method 65%)	KAF556D80	KAF556D160	
			(Colorimetric method 90%)	KAF557D80	KAF557D160	
6	Replacement high-efficiency filter ^{9,10}		(Colorimetric method 65%)	KAF552D80	KAF552D160	
			(Colorimetric method 90%)	KAF553D80	KAF553D160	
7	Filter chamber			KDDFP55C160		
8	Replacement long-life filter			KAF5511D160		
9	Replacement long-life filter (Auto grille panel)			KAF5512D160		
10	Ultra long-life filter unit (Including filter chamber) ⁹			KAF555D160		
11	Replacement ultra long-life filter ^{9,10}			KAF550D160		
12	Branch duct chamber ⁴			KDJP55C80	KDJP55C160	
13	Insulation kit for high humidity ^{9,11}			KDTP55K80A	KDTP55K160A	

Note: 1. When installing designer panel, body height (ceiling required dimension) is 42 mm higher than standard panel. Designer panel cannot operate 2 and 3 way flow.
 2. A dedicated wireless remote controller (BRC16A2) for the auto grille panel is included for lowering and raising the suction grille.
 3. When installing auto grille panel, body height (ceiling required dimension) is 55 mm higher than standard panel.
 4. Circulation airflow is not available with this option.
 5. When installing a fresh air intake kit (chamber type), two air outlet corners are closed.
 6. It is recommended that the volume of outdoor air introduced through the kit is limited to 10% of the maximum airflow rate of the indoor unit. Introducing higher quantities will increase the operating sound and may also influence temperature sensing.

7. The volume of fresh air for direct installation type is approximately 1% of the indoor unit airflow. The chamber type is recommended when more fresh air is necessary.
 8. Please order using the names of both components instead of set name.
 9. This option cannot be installed to designer panel and auto grille panel.
 10. Filter chamber is required.
 11. Please use in case temperature/humidity inside ceiling may get over 30°C, 80% RH.
 *These panels do not contain the sensing function.

Option List

Indoor Units

Options of Ceiling Mounted Cassette (Round Flow with Sensing & Round Flow) Type

Options required for specific operating environments

Ultra long-life filter unit

Even in dusty environments where the air conditioning is constantly operating, the ultra long-life filter only has to be cleaned once a year.

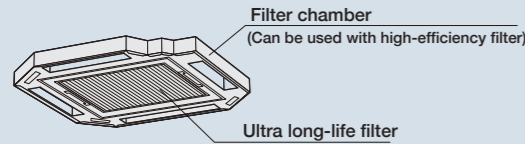

Dusty area: annual filter change
 *For dust concentration of 0.3 mg/m³ (Requires separately sold Air purifier.)
 1 year (Approx. 5,000 hr) ≈ 15 hr/day x 28 day/month x 12 month/year

Ordinary store or office: filter change every 4 years
 *For dust concentration of 0.15 mg/m³
 4 years (Approx. 10,000 hr) ≈ 8 hr/day x 25 day/month x 12 month/year

High-efficiency filter unit

Available in two types: 65% and 90% colorimetry.

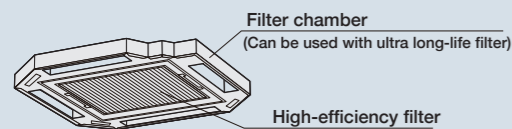

Insulation kit for high humidity

Please use if you think the temperature and humidity inside the ceiling exceeds 30°C and RH 80%, respectively.

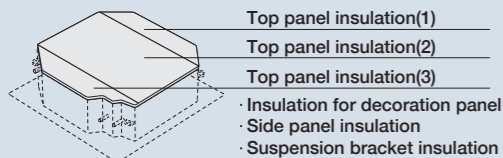

Panel spacer

Use when only minimal space is available between drop ceilings and ceiling slabs.

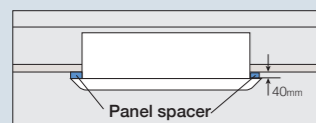

Note: Some ceiling constructions may hinder installation. Contact your Daikin Dealer before installing your unit.

Sealing material of air discharge outlet

Sealing material block air discharge openings not used in 2-way or 3-way blow.

Branch duct chamber

This chamber lets you connect a round flexible duct to the air discharge opening at any time after the original installation.

Fresh air intake kit Note 1, 2

Using this kit, a duct can be connected to take in outdoor air. There are two chamber types that have intake in two places: with T-duct joint and without T-duct joint.

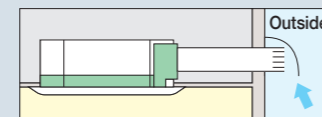

The units can be installed in the following different ways

Chamber type (without T-duct joint) Note 3, 4, 5

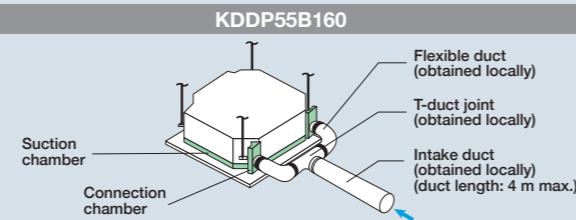

Chamber type (with T-duct joint) Note 3, 4, 5

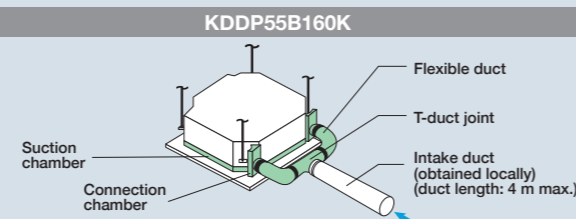

Direct installation type Note 6

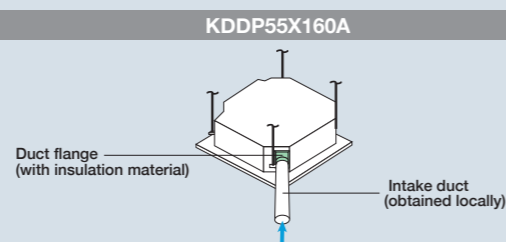

- Note: 1. Use of options will increase operating sound.
 2. Connecting ducts, fan, insect nets, fire dampers, air filters, and other parts should, as required, be obtained locally.
 3. When a local-obtained fan is used, an interlock with air conditioner is necessary. Optional PCB (KRP1C11A) is required for interlocking.
 4. When installing a fresh air intake kit (chamber type), two air outlet corners are closed.
 5. It is recommended that the volume of outdoor air introduced through the kit is limited to 10% of the maximum airflow rate of the indoor unit. Introducing higher quantities will increase the operating sound and may also influence temperature sensing.
 6. The volume of fresh air for direct installation type is approximately 1% of the indoor unit airflow. The chamber type is recommended when more fresh air is necessary.

Ceiling Mounted Cassette (Compact Multi Flow) Type

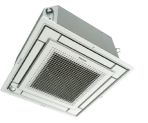

No.	Item	Type	FXZQ20A	FXZQ25A	FXZQ32A	FXZQ40A	FXZQ50A
1-1	Grid ceiling panel				BYFQ60CAW		
1-2	Sensor kit for grid ceiling panel				BRYQ60AAW		
2-1	Decoration panel ^{*1}				BYFQ60B3W1		
2-2	Relay wire harness adaptor for decoration panel ^{*1}				BER01A1		
2-3	Sealing material of air discharge outlet for decoration panel				KDBH44BA60		
3	Replacement long life filter				KAF441C60		
4	Fresh air intake kit				KDDQ44XA60		

Note: 1. Option relay wire harness adaptor (BER01A1) is necessary when installing decoration panel (BYFQ60B3W1).

4-Way Flow Ceiling Suspended Type



No.	Item	Type	FXUQ71A	FXUQ100A
1	Sealing material of air discharge outlet			KDBHP49B140
2	Decoration panel for air discharge			KDBTP49B140
3	Replacement long-life filter			KAF5511D160

Ceiling Mounted Cassette (Double Flow) Type

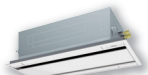

No.	Item	Model	FXCQ20A	FXCQ25A	FXCQ32A	FXCQ40A	FXCQ50A	FXCQ63A	FXCQ80A	FXCQ125A
1	Decoration panel			BYBCQ40CF			BYBCQ63CF		BYBCQ125CF	
2	High efficiency filter *1	65 %		KAF532C50			KAF532C80		KAF532C160	
		90 %		KAF533C50			KAF533C80		KAF533C160	
3	Filter chamber for bottom suction			KDDFP53B50			KDDFP53B80		KDDFP53B160	
4	Long life replacement filter			KAF531C50			KAF531C80		KAF531C160	

Note: *1. If installing high efficiency filter, filter chamber is required.

Ceiling Mounted Cassette Corner Type

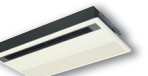

No.	Item	Type	FXKQ25MA	FXKQ32MA	FXKQ40MA	FXKQ63MA
1	Panel related	Decoration panel		BYK45FJW1		BYK71FJW1
2	Air inlet and air discharge outlet related	Long life replacement filter		KAFJ521F56		KAFJ521F80

Slim Ceiling Mounted Duct Type

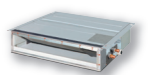

No.	Item	Type	FXDQ20PD	FXDQ25PD	FXDQ32PD	FXDQ40ND	FXDQ50ND	FXDQ63ND
1	Insulation kit for high humidity			KDT25N32		KDT25N50		KDT25N63

Middle Static Pressure Ceiling Mounted Duct Type

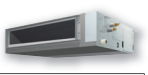

No.	Item	Type	FXSQ20PA FXSQ25PA FXSQ32PA	FXSQ40PA	FXSQ50PA FXSQ63PA FXSQ80PA	FXSQ100PA FXSQ125PA	FXSQ140PA
1	High efficiency filter *1	65%	KAF632C36	KAF632C56	KAF632C80	KAF632C160	KAF632B160B
		90%	KAF633C36	KAF633C56	KAF633C80	KAF633C160	KAF633B160B
2	Filter chamber (for rear suction) *1		KDDFP63B36	KDDFP63B56	KDDFP63B80	KDDFP63B160	KDDFP63B160B
3	Long-life filter *1		KAF631C36	KAF631C56	KAF631C80	KAF631C160	KAF631B160B
4	Service panel	White	KTBJ25K36W	KTBJ25K56W	KTBJ25K80W		KTBJ25K160W
		Fresh white	KTBJ25K36F	KTBJ25K56F	KTBJ25K80F		KTBJ25K160F
		Brown	KTBJ25K36T	KTBJ25K56T	KTBJ25K80T		KTBJ25K160T
5	Air discharge adaptor		KDAP25A36A	KDAP25A56A	KDAP25A71A	KDAP25A140A	KDAP25A160A *2
6	Shield plate for side plate				KDBD63A160		-

Note: *1. If installing high efficiency filter and long-life filter to the unit, filter chamber is required.
 *2. This option is a set of KDAP25A140A and KDBHP37A160.

Indoor Units

Ceiling Mounted Duct Type



No.	Item	Type	FXMQ20PA	FXMQ40PA	FXMQ50PA	FXMQ100PA	FXMQ200M
			FXMQ25PA FXMQ32PA		FXMQ63PA FXMQ80PA	FXMQ125PA FXMQ140PA	FXMQ250M
1	Drain pump kit						KDU30L250VE
2	High efficiency filter	65%	KAF372AA36	KAF372B56	KAF372B80	KAF372B160	KAFJ372M280
		90%	-	KAF373B56	KAF373B80	KAF373B160	KAFJ373M280
3	Filter chamber		-	KDDF37AA56	KDDF37AA80	KDDF37AA160	KDJ3705L280
4	Long life replacement filter		-	-	-	-	KAFJ371M280
5	Long life filter chamber kit		-	KAF371B56	KAF371B80	KAF371B160	-
6	Service panel	White	KTBJ25K36W	KTBJ25K56W	KTBJ25K80W	KTBJ25K160W	-
		Fresh white	KTBJ25K36F	KTBJ25K56F	KTBJ25K80F	KTBJ25K160F	-
		Brown	KTBJ25K36T	KTBJ25K56T	KTBJ25K80T	KTBJ25K160T	-
7	Air discharge adaptor		KDAJ25K36A	KDAJ25K56A	KDAJ25K71A	KDAJ25K140A	-

Ceiling Suspended Type



No.	Item	Type	FXHQ32MA	FXHQ63MA	FXHQ100MA	FXHQ125A	FXHQ140A
			1	Drain pump kit	KDU50N60VE	KDU50N125VE	KDU50R160
2	Replacement long-life filter		KAFJ501D56	KAFJ501D80	KAFJ501D112	KAF501B160	
3	L-type piping kit (for upward direction)		KHFP5M63	KHFP5M160		KHFP5N160	
4	Fresh air intake kit					KDDQ50A140	

Wall Mounted Type



No.	Item	Type	FXAQ20A	FXAQ25A	FXAQ32A	FXAQ40A	FXAQ50A	FXAQ63A
			1	Drain pump kit				

Floor Standing Type



No.	Item	Type	FXLQ20MA	FXLQ25MA	FXLQ32MA	FXLQ40MA	FXLQ50MA	FXLQ63MA
			1	Long life replacement filter		KAF361L28	KAF361L45	KAF361L71

Concealed Floor Standing Type



No.	Item	Type	FXNQ20MA	FXNQ25MA	FXNQ32MA	FXNQ40MA	FXNQ50MA	FXNQ63MA
			1	Long life replacement filter		KAF361L28	KAF361L45	KAF361L71

Control Systems



Operation Control System Optional Accessories For VRV indoor unit use

No.	Item	Type	FXFSQ-A	FXFQ-A	FXZQ-A	FXCQ-A	FXKQ-MA	FXDQ-PD FXDQ-ND	FXSQ-PA
			1	Stylish remote controller					
2	Navigation remote controller		BRC1E63 *5						BRC1E63
3	Simplified remote controller								BRC2E61
4	Wireless remote controller	C/O	BRC7M635F (Fresh White) BRC7M635K (Black)		BRC7M531W (for grid ceiling panel) BRC7E531W (for decoration panel)	BRC7M66	BRC4C63		BRC4C66
		H/P	BRC7M634F (Fresh White) BRC7M634K (Black)		BRC7M530W (for grid ceiling panel) BRC7E530W (for decoration panel)	BRC7M65	BRC4C61		BRC4C65
5-1	Adaptor for wiring (operation status output)								★BRP11B62
5-2	Adaptor for wiring								★KRP1C14A
6-1	Wiring adaptor for electrical appendices (1)								KRP1B61
6-2	Wiring adaptor for electrical appendices (2)								★KRP2A51
									★KRP2A53
7	Remote sensor (for indoor temperature)		BRC01A-5		BRC01A-6				BRC01A-1
8	Installation box for adaptor PCB		KRP1H98A *2,3		KRP1BB101 *4	KRP1C96 *2,3			KRP1BB101 *4
9	External control adaptor for outdoor unit								★DTA104A61
10	Multi tenant unit for Indoor (24 V free type)								★BRP114A61

No.	Item	Type	FXMQ-PA	FXMQ-M	FXUQ-A	FXHQ-MA	FXHQ-A	FXAQ-A	FXLQ-MA FXNQ-MA
			1	Stylish remote controller					
2	Navigation remote controller								BRC1E63
3	Simplified remote controller								BRC1E63
4	Wireless remote controller	C/O	BRC4C66	BRC4C64	BRC7CB59	BRC7EA66	BRC7M56	BRC7M676	BRC4C64
		H/P	BRC4C65	BRC4C62	BRC7CB58	BRC7EA63W	BRC7M53	BRC7M675	BRC4C62
5-1	Adaptor for wiring (operation status output)		★BRP11B62	BRP11B62					★BRP11B61
5-2	Adaptor for wiring								
6-1	Wiring adaptor for electrical appendices (1)		★KRP2A61	KRP2A61		★KRP2A62			★KRP2A61
6-2	Wiring adaptor for electrical appendices (2)		★KRP4AA51	KRP4AA51	★KRP4AA53		★KRP4AA52		★KRP4AA51
7	Remote sensor (for indoor temperature)		BRC01A-4	BRC01A-1	BRC01A-4	BRC01A-1	BRC01A-4	BRC01A-6	BRC01A-1
8	Installation box for adaptor PCB		KRP4A97 *2,3		KRP1BA97	KRP1CA93 *3	KRP1D93A *3		KRP4B93 *2,3
9	External control adaptor for outdoor unit		★DTA104A61	DTA104A61			★DTA104A62		★DTA104A61
10	Multi tenant unit for Indoor (24 V free type)		★BRP114A61						★BRP114A61

Notes: 1. Installation box is necessary for each adaptor marked ★.
 2. Up to 2 adaptors can be fixed for each installation box.
 3. Only one installation box can be installed for each indoor unit.
 4. Up to 2 installation boxes can be installed for each indoor unit.
 5. Some functions can be set only via the wired remote controller BRC1E63. They cannot be set via other remote controllers. Please refer to each indoor unit and remote controller page for function details.

Adaptor for wiring (operation status output)
 By installing it in the indoor unit with a simple wire connection, this adaptor takes out the operating signals for the indoor unit fan and the compressor and enables the interlocking of equipment such as the ventilation fan.



Example:
 Interlocking operation of the indoor unit and ventilation fan that takes in fresh air.

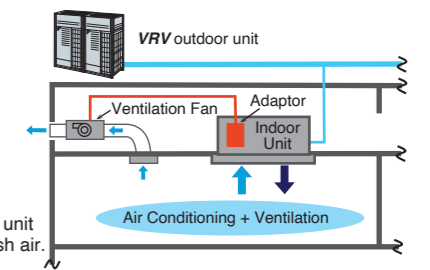

For residential indoor unit use

No.	Item	Type	CDXS-EA FDXS-C	FTXS-D, E, F
			1	Remote controller
2	Wiring adaptor for time clock/remote controller *2 (Normal open pulse contact/normal open contact)			KRP413BB1S
3	Remote controller loss prevention chain			KKF917A4
4	Interface adaptor for DIII-NET use			KRP928BB2S

Notes: 1. A wireless remote controller is a standard accessory.
 2. Time clock and other devices should be obtained locally.

Option List

System Configuration

No.	Item	Model No.	Function
1	Residential central remote controller	DCS303A51 *2	<ul style="list-style-type: none"> Up to 16 groups of indoor units (128 units) can be easily controlled using the large LCD panel. ON/OFF, temperature settings and scheduling can be controlled individually for indoor units.
2	Interface adaptor for residential indoor units	KRP928BB2S	<ul style="list-style-type: none"> Adaptors required to connect products other than those of the VRV System to the high-speed DIII-NET communication system adopted for the VRV System. * To use any of the above optional controllers, an appropriate adaptor must be installed on the product unit to be controlled.
3	Interface adaptor for SkyAir-series	★DTA112BA51 *3	
4	Central control adaptor kit For UAT(Y-K(A),FD-K	★DTA107A55	
5	Wiring adaptor for other air-conditioner	★DTA103A51	
6	DIII-NET expander adaptor	DTA109A51	
6-1	External control adaptor	DTA104A61	<ul style="list-style-type: none"> Demand control of individual or multiple systems. Low noise option for individual or multiple systems.
6-2	Mounting plate	BKS26A	<ul style="list-style-type: none"> When installing DTA109A51, DTA104A61 into outdoor units of 14 HP (VRV H/A) or larger.
7-1	Multi tenant unit for Indoor (24 V free type)	BRP114A61 *4, 5	<ul style="list-style-type: none"> Use in multi tenant buildings where one tenant shuts off the breaker of the indoor unit. Max. length from outdoor unit to last indoor unit per 1 outdoor adaptor is 200 m. 8 indoor units can be connected per 1 outdoor adaptor. Use when extending transmission length with the multi tenant option. Can add Max. 3 booster units to 1 system. Total transmission length is Max. 800 m. Total connectable indoor units is Max. 32 units.
7-2	Multi tenant unit for Outdoor (24 V free type)	BRP114A62 *4	
7-3	Multi tenant unit Booster (24 V free type)	BRP114A63 *4	

Notes: 1. Installation box for ★ adaptor must be obtained locally.
2. For residential use only. Cannot be used with other centralised control equipment.

3. No adaptor is required for some indoor units.
4. Because the maximum transmission length varies according to actual installation conditions and diameter of wiring used, please confirm by a dedicated simulator.
5. Installation box is necessary for adaptor BRP114A61. Please refer to option list for each indoor unit.

Building Management System

No.	Item			Model No.	Function		
1	intelligent Touch Controller	Basic	Hardware	intelligent Touch Controller	DCS601C51	<ul style="list-style-type: none"> Air-Conditioning management system that can be controlled by a compact all-in-one unit. 	
1-1		Option	Hardware	DIII-NET plus adaptor	DCS601A52	<ul style="list-style-type: none"> Additional 64 groups (10 outdoor units) is possible. 	
1-2		Option	Software	Web software	DCS004A51	<ul style="list-style-type: none"> VRV system that is connected to intelligent Touch Controller can be operated from the user's PC via a web page. 	
1-3	Electrical box with earth terminal (4 blocks)			KJB411A	<ul style="list-style-type: none"> Wall embedded switch box. 		
2	intelligent Touch Manager	Basic	Hardware	intelligent Touch Manager	DCM601A51	<ul style="list-style-type: none"> Air-conditioning management system that can be controlled by touch screen. 	
2-1		Option	Hardware	iTM plus adaptor	DCM601A52	<ul style="list-style-type: none"> Additional 64 groups (10 outdoor units) is possible. Max. 7 iTM plus adaptors can be connected to intelligent Touch Manager. 	
2-2		Option	Software	iTM power proportional distribution	DCM002A51	<ul style="list-style-type: none"> Power consumption of indoor units are calculated based on operation status of the indoor unit and outdoor unit power consumption measured by kWh metre. 	
2-3		Option	Software	iTM energy navigator	DCM008A51	<ul style="list-style-type: none"> Building energy consumption is visualised. Wasted air-conditioning energy can be found out. 	
2-4		Option	Software	BACnet® client	DCM009A51	<ul style="list-style-type: none"> BACnet® equipment can be managed by intelligent Touch Manager. 	
2-5		Option	Software	HTTP Interface	DCM007A51	<ul style="list-style-type: none"> Interface for intelligent Touch Manager by HTTP 	
2-6		Office	Basic	Hardware	Reiri for Office	DCPF01	<ul style="list-style-type: none"> VRV smart controller (website or mobile app via smart phone or tablet) for small to medium scale building
2-7					Reiri for Office (Touchscreen Controller)	DCPF04	<ul style="list-style-type: none"> VRV smart controller with touch panel (website or mobile app via smartphone or tablet) for small to medium scale building
2-8					Reiri for Office (Controller Extension)	DCPF05	<ul style="list-style-type: none"> VRV smart controller for large scale building
2-9		Smartphone/ Tablet control	Basic	Hardware	Reiri for Office (Multisite Extension)	DCPF10	<ul style="list-style-type: none"> Control all VRV units via Reiri for Office on multisite
2-10	Reiri for Office				DCPH01	<ul style="list-style-type: none"> VRV smart home automation and smart control solution 	
2-11	Reiri for Home (Lite Version)				DCPH02	<ul style="list-style-type: none"> VRV smart centralised controller 	
2-12	Hotel	Basic	Hardware	Reiri for Hotel	DCPL01	<ul style="list-style-type: none"> Multiple hotel room air conditioner interlocking with occupancy signal, window open/close signal and check in/out signal 	
2-13				Reiri for Resort	DCPR01	<ul style="list-style-type: none"> Individual villa air conditioner interlocking with occupancy signal, window open/close signal and check in/out signal 	
2-14	Di unit			DEC101A51	<ul style="list-style-type: none"> 8 pairs based on a pair of ON/OFF input and abnormality input. 		
2-15	Dio unit			DEC102A51	<ul style="list-style-type: none"> 4 pairs based on a pair of ON/OFF input and abnormality input/output. 		
3	Communication interface	Basic	Hardware	Interface for use in BACnet® *1	DMS502B51	<ul style="list-style-type: none"> Interface unit to allow communications between VRV and BMS. Operation and monitoring of air-conditioning systems through BACnet® communication. 	
3-1				Optional DIII board	DAM411B51	<ul style="list-style-type: none"> Expansion kit, installed on DMS502B51, to provide 2 more DIII-NET communication ports. Not usable independently. 	
3-2				Optional Di board	DAM412B51	<ul style="list-style-type: none"> Expansion kit, installed on DMS502B51, to provide 16 more wattmeter pulse input points. Not usable independently. 	
4				Interface for use in LONWORKS® *2	DMS504B51	<ul style="list-style-type: none"> Interface unit to allow communications between VRV and BMS. Operation and monitoring of air-conditioning systems through LonWorks® communication. 	
5				Home Automation Interface Adaptor	DTA116A51	<ul style="list-style-type: none"> Use of the Modbus® protocol enables the connection of the VRV system with a variety of home automation systems from other manufacturers. *4 	
5-1				Mounting plate	BKS26A	<ul style="list-style-type: none"> When installing DTA116A51 into outdoor units of 14 HP (VRV H/A) 28 HP (VRV R) or larger. 	
6	Contact/ analogue signal	Basic	Hardware	Unification adaptor for computerised control	★DCS302A52	<ul style="list-style-type: none"> Interface between the central monitoring board and central control units. 	

Notes: *1. BACnet® is a registered trademark of American Society of Heating, Refrigerating and Air-Conditioning Engineers (ASHRAE).

*2. LonWorks® is a trademark of Echelon Corporation registered in the United States and other countries.

*3. Installation box for ★ adaptor must be obtained locally.

*4. Modbus® is a registered trademark of Schneider Electric S.A.